

DOCUMENT RESUME

ED 287 667

SE 048 618

TITLE Energy Conservation Activities for Elementary Grades (Or: How To Help Slim Down the Energy Monster). Iowa Developed Energy Activities Sampler, Intermediate 3-5. Revised.

INSTITUTION Iowa State Dept. of Education, Des Moines.

SPONS AGENCY Iowa State Dept. of Natural Resources, Des Moines. Energy Div.

PUB DATE 87

NOTE 135p.; For a prior edition, see ED 275 527. Drawings may not reproduce well.

PUB TYPE Guides - Classroom Use - Guides (For Teachers) (052)

EDRS PRICE MF01/PC06 Plus Postage.

DESCRIPTORS Cognitive Processes; Electricity; Elementary Education; \*Elementary School Curriculum; \*Energy Conservation; \*Energy Education; Environmental Education; Grade 3; Grade 4; Grade 5; Instructional Materials; Interdisciplinary Approach; \*Learning Activities; Learning Processes; Piagetian Theory; Science Education; Social Studies; State Curriculum Guides

IDENTIFIERS \*Iowa

ABSTRACT

The revised Iowa Developed Energy Activity Sampler (IDEAS) was compiled using the original IDEAS program and the Energy Conservation Activity Packets (ECAPS). This booklet provides activities for teachers in the intermediate elementary grades (3-5) and is designed to enable students to develop a comprehensive understanding of energy concepts. Each of the 22 activities include: (1) the subject area for which the activity was written; (2) the grade level; (3) a brief statement about the activity itself; (4) the objective(s) of the activity; (5) a list of materials needed; (6) the approximate amount of time needed for the activity; (7) a more complete description of the activity, including the various components of the activity and their relationship to Jean Piaget's learning cycle (awareness, concept development, application); and (8) some follow-up/background information. In some activities the original source of the activity is also given. The focal points of the entire document are energy concerns, impacts, choices, challenges, and conservation. (TW)

\*\*\*\*\*  
 \* Reproductions supplied by EDRS are the best that can be made \*  
 \* from the original document. \*  
 \*\*\*\*\*

This document has been reproduced as received from the person or organization originating it  
 Minor changes have been made to improve reproduction quality

• Points of view or opinions stated in this document do not necessarily represent official OERI position or policy

"PERMISSION TO REPRODUCE THIS MATERIAL HAS BEEN GRANTED BY

*Dean Crocker*

TO THE EDUCATIONAL RESOURCES INFORMATION CENTER (ERIC)."

ED287667

# Iowa Developed Energy Activities Sampler

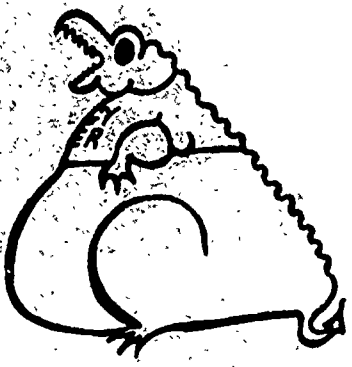

# Energy Conservation Activities for Elementary Grades

(Or: How to Help Slim Down the Energy Monster)



SE 048618

## Intermediate 3-5

State of Iowa  
DEPARTMENT OF EDUCATION  
Grimes State Office Building  
Des Moines, Iowa 50319-0146

STATE BOARD OF EDUCATION

Lucas DeKoster, President, Hull  
Dianne L.D. Paca, Vice-President, Garner  
Betty L. Dexter, Davenport  
Thomas M. Glenn, Des Moines  
Karen K. Goodenow, Wall Lake  
Francis N. Kenkel, Defiance  
John Moats, Council Bluffs  
Mary E. Robinson, Cedar Rapids  
Harlan W. Van Gerpen, Cedar Falls

ADMINISTRATION

Robert D. Benton, Director of the Department of Education  
Mavis Kelley, Administrative Assistant  
James E. Mitchell, Deputy Director

Instructional Services Division

Carol McDanolds Bradley, Administrator  
A. John Martin, Chief, Instruction and Curriculum Bureau  
Duane Toomsen, Consultant, Environmental Education

Funds for development and printing provided  
under contract to the Department from the

Energy Division  
Iowa Department  
of  
Natural Resources

## Table of Contents

### INTERMEDIATE ENERGY ACTIVITIES

	Page
Acknowledgements. . . . .	iii
Energy Dramatics. . . . .	I-1
Go With The Flow. . . . .	I-2
My, How You've Changed. . . . .	I-3
Dig It! . . . . .	I-4
Petroleum Pets. . . . .	I-5
The Petroleum Blues in the News . . . . .	I-6
Chariots to Rockets . . . . .	I-7
You Auto Walk . . . . .	I-8
Calculating Car Costs - Wheeling and Dealing. . . . .	I-9
Operation Pipeline. . . . .	I-10
Turn That Turbine . . . . .	I-11
What Is My Electrical Future? . . . . .	I-12
Electrical Lifestyle. . . . .	I-13
Consumption! My How You've Grown . . . . .	I-14
Catch a Sunbeam . . . . .	I-15
Buy Rights. . . . .	I-16
Twinkie, Twinkie That's Your Name How I Wonder Whence You Came . . . . .	I-17
Energy Patrol . . . . .	I-18
Energize Me . . . . .	I-19
Saving Energy Makes Good Cents. . . . .	I-20
Making the Grade. . . . .	I-21
Is That A Fact? . . . . .	I-22

## REVISED IOWA DEVELOPED ENERGY ACTIVITY SAMPLER - IDEAS

## INTRODUCTION TO IDEAS

The revised IDEAS were developed from the Energy Conservation Activity Packets, (ECAPS), by Ruth Baake, and Iowa Developed Energy Activity Sampler (IDEAS), developed by Dr. Doris G. Simonis under the auspices of the Iowa Energy Policy Council and the Iowa Department of Public Instruction, now the Iowa Department of Education. An "infusion model" was used as a basic framework which recognized the interdisciplinary nature of energy education concepts. These included:

1. Energy is basic.
2. Energy usefulness is limited.
3. Environment is impacted by energy exchanges.
4. Energy conservation is needed.
5. The future of energy is ours to shape and share.

The revised IDEAS adheres to these concepts and provides activities that utilize a learning cycle to develop a knowledgeable student population concerning energy matters. Decision-making skills are emphasized and developing an energy conservation ethic is a major goal.

Under the joint sponsorship of the Iowa Department of Education, Duane Toomsen, Environmental and Energy Education Consultant, and the Energy Division of the Iowa Department of Natural Resources, Dr. W. Tony Heiting, Coordinator; the revised Iowa Developed Energy Activity Sampler (IDEAS) was created to meet the continuing need for energy education from the 1980's into the twenty-first century.

Conservation of natural resources and environmental awareness has been mandated by the State of Iowa to become a part of the quality education experienced by Iowa's future citizens in grades K-12. Energy is an integral part of our nation's natural resource base. The major emphasis of IDEAS is to provide uniquely designed K-12 classroom activities that are adaptable into various classroom situations, i.e., highly populated, urban schools to less populated rural facilities. The focal points of IDEAS are: energy concerns, impacts, choices, challenges, and conservation.

Revised IDEAS adopts a learning cycle strategy based upon the learning theory of Jean Piaget. The cycle has three phases: awareness, concept development and application. Activities are loosely structured to allow for student exploring hypothesizing, and decision-making.

Awareness activities encourage students to experience a new idea, phenomenon or perception. A variety of experiences should stimulate the students' interest, appreciation, and initiate a positive attitude toward the concept to be formulated. Concept development involves the building of a concept of energy based upon the awareness phase. Concept development may include such activities as reading, performing experiments, solving problems, group interactions, games and role-playing in order to reinforce the developing concept. The application phase is designed to enable the student to apply the new concept to various situations or problems. Application activities may include the same types of activities plus a gamut of others, including debates, panels, simulations, surveys, designing, constructing and community or school projects.

This learning cycle approach integrates content with processes and encourages the development of higher level reasoning and thinking skills. The interdisciplinary importance of energy education is emphasized.

The activity format used in the revised edition of IDEAS includes a title, subject and grade level designation, a short description of the activity, learning objectives, materials needed, approximate time required, and descriptions of the three phases of the activity. A suggested evaluation section has been included, in most packets, to assist the instructor and/or learner in determining the extent to which each learner achieved each objective. Follow-up or background information and a detailed activity description complete the format.

Iowa is an excellent example of how energy is an interrelated and interdependent resource. Iowa imports 98% of the energy it uses and has a high potential for reducing its dependence on outside energy sources through conservation and alternative energy forms. Iowa's current energy dependence has a major impact on Iowa's economy and the ability of the state to compete in the industrial and agricultural community. All segments of Iowa's society involving service-related employment, agriculture, and industry, are impacted by energy costs and availability.

The most obvious means of energy reduction is energy conservation. More efficient use of energy resources available in Iowa (i.e. coal, wind, hydro, solar, gasohol, biomass) can have a significant impact on the cost of production/distribution factors as fossil fuels begin to diminish in the twenty-first century.

The revised IDEAS were developed by classroom teachers who realize the need to provide students with an enriched curriculum. Iowa's tradition of excellence in education has always pointed toward an improved future for our youth. IDEAS will provide the creative educator with a multitude of activities from which they can choose, adapt, and improve.

The professional educator who uses IDEAS may adapt the activities for any classroom setting. Students will be given the basis to form an energy attitude, ethic, and philosophy which will serve them and the citizens of Iowa throughout life.

Members of the IDEAS Revision Committee

Duane Toomsen, Environmental and Energy Consultant, Department of Education

Dr. Tony Heiting, Research/Education Director, Energy Division, Iowa Department of Natural Resources.

Dr. Bob Vanden Branden, University of Northern Iowa, editor.

The following were responsible for the grade and/or subject level indicated:

Primary	Linda Scheuermann	Roland-Story Elementary School Story City, Iowa
Intermediate	Janey Swartz	Sac and Fox Settlement School Tara, Iowa
Home Economics	Viki Van Ryswyk	Lewis Central High School Council Bluffs, Iowa
Industrial Arts and Technology Education	Alan Glass	Ballard High School Huxley, Iowa
Language and Creative Arts	Dr. Doug Larche	Grandview College Des Moines, Iowa
Mathematics	Dorothea Trost	Sutherland Community High School, Sutherland, Iowa
Science	Peggy Steffen	Ottumwa High School Ottumwa, Iowa
Social Studies	Steve Heiting	Oskaloosa High School Oskaloosa, Iowa

Advisory members included:

Dr. Lynn Glass, Iowa State University  
Brian Johnson, Iowa Power and Light

Special Tribute to Jody Cosson, Des Moines Graphic Artist

Notebook Cover by Carol Doerr



## RESOURCE ORGANIZATIONS

Iowa Department of Natural Resources, Energy Division,  
Wallace Building, Des Moines, Iowa 50319

CAREIRS (Conservation and Renewable Energy Inquiry and Referral Service)  
800-523-2929.

Iowa Energy Extension Service, Iowa State University,  
110 Marston Hall, Ames, Iowa 50011. 515/294-6978

National Energy Foundation, 4980 West Amelia Earhart Drive  
Salt Lake City, Utah, 84116. 801/539-1406

Energy and Self-Reliance Center, 3500 Kingman Boulevard  
Des Moines, Iowa 50311. 515/277-0253

National Energy Information Center, E1-20, Energy Information  
Administration, Forrestal Building, Room 1F-048  
Washington, D.C. 20585. 202/252-8800

New York Energy Education Project and the  
Solar Energy Project, SUNY at Albany, 1400 Washington Avenue  
P.O. Box 22100, Albany, New York 12222

Ministry of Energy, 56 Wellesley Street West,  
Toronto, Ontario, M7A2B7, Canada

NATAS (National Appropriate Technology Assistance Service) 800-428-2525.

The NEED Project, P.O. Box 2518, Reston, Virginia 22090  
703/860-5029

U.S. Government Printing Office, Washington, D.C. 20402

Your local public utility



## INTERMEDIATE INTRODUCTION

The intermediate materials were designed to enable the student to develop a comprehensive understanding of energy concepts and choices. Activities are loosely ordered to provide a sequential flow of energy information. It is desirable, but not essential, to present the activities in the order given.

The activities are composed of concrete, hands-on activities in the learning cycle format. Each student should keep the activities in an energy folder. Throughout the entire unit, the students will examine their own lifestyles, form opinions (values), make choices, and develop a conservation ethic.

The intent of these materials is for the teacher to use this unit as a springboard for the student's lifetime commitment to a conservation ethic starting in the school and continuing throughout life.

A special thanks to the following people for their contribution to the project.

- |                              |                                                                                     |
|------------------------------|-------------------------------------------------------------------------------------|
| Marilyn Benson               | - Fremont Mills Community School District                                           |
| Gale Brown                   | - Underwood Community School District                                               |
| John Ehn                     | - BCL Community School District                                                     |
| Lorraine Hoack               | - Decorah Community School District                                                 |
| John Glenn Elementary School | - North Scott Community School District                                             |
|                              | Joe Ragona, Principal                                                               |
|                              | Tom Fredrickson, Mississippi Bend AEA                                               |
| Shirley Lee                  | - Howard Winneshiek Community School District                                       |
| LaVerne Logan                | - MFL Community School District                                                     |
| John and Deb Miller          | - Department of Education of Minnesota and<br>St. Paul Academy, St. Paul, Minnesota |
| Sindy Stiles                 | - Fort Dodge Community School District                                              |
| Sheree Pandil                | - Fort Dodge Community School District                                              |
| Duane Toomsen                | - Department of Education                                                           |
| Rose Marie Wilson            | - Sheldon Community School District                                                 |

**TITLE** Energy Dramatics

**SUBJECT** Creative Dramatics/Science

**LEVEL** Intermediate

**ACTIVITY IN BRIEF**

Students "act out" an energy flow sequence directed by the teacher and then produce one of their own energy flows.

**OBJECTIVE**

Each student will be able to identify the major energy sources

**MATERIALS**

oak tag/string  
 markers/paint/a. supplies as needed  
 for mobile  
 handouts (1b, 1c, 1d)

**TIME**

awareness - 20 minutes  
 concept development - 15  
 minutes  
 application 30-45 minutes

**LEARNING CYCLE**

**AWARENESS** - The teacher directs the sun-to-radio-station-energy flow (see I-1a). A diagram is drawn on the board to illustrate the energy flow.

**CONCEPT DEVELOPMENT** - Students complete the "What Makes It Go?" worksheet (see I-1b). The students will have to determine the source of electricity generation within their area. A call to the local power plant will provide the answer. The students will read the information about the primary energy sources (I-1c) and then do the Energy Source Game (see I-1d).

**APPLICATION** - The students form groups of 3 or 4. The teacher will give each group a secret energy source. Each group will produce and present to the rest of the class an energy flow sequence using that energy source. The audience will try to guess the energy source. (No guesses until the presenting group indicates its completion!) Each group will create a symbol for its energy source on a piece of pegboard. All symbols will come together to form an energy source mobile to be hung in the classroom.

**EVALUATION** - The student will label the symbols of the energy sources. (See I-1e).

**FOLLOW-UP/BACKGROUND INFORMATION**

**SOURCE OF ACTIVITY** - Windmill Activity by Duane Toomsen. Energy Source Game by Steve Heiting.

## SUN-TO-RADIO ENERGY FLOW

To demonstrate visually the concept of energy conversions, the following describes an activity that allows for active participation of all members of a class in an energy conversion simulation.

One individual is selected (usually wearing yellow or orange) to represent the sun. This individual can practice dramatic sun rises while other groups are being organized.

Five or less individuals will form a windmill that turns clockwise with left arm extended to form vases. After the sun rises, light energy is converted to heat energy, which warms the air molecules. Movement by air molecules and other extenuating circumstances causes the wind to blow, thereby turning the mechanism that activates the electrical generating turbine. (This group may practice roles.)

Five or less individuals form a circle with their backs toward the center. They place their arms around one another's waist, and as the windmill begins to turn they gently bump hips to simulate electrical energy generation. This is the electrical turbine, and they may wish to practice their assignment.

One radio announcer using body energy and electrical energy will communicate via sound energy to the listening audience from radio station KNRG. The announcer will sign on giving details about the call letters, station location, time, weather, etc.

Two individuals will do a heat dance by moving throughout the room demonstrating heat (waste) being given off by friction in the windmill, turbine, electrical generating lines, by the body of the radio announcer, and the equipment this person is using.









All remaining individuals will form a transmission line directing the energy flow from the turbine to the radio announcer. By holding hands they will simulate energy electrical flow by gentle squeezing of one another's hands.

#### Conversion Process

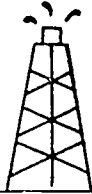
Sunlight - Light to heat energy, wind to electrical energy, back to heat, light and sound. Heat is the lowest form of energy and most difficult to concentrate effectively and efficiently. Students will be able to observe simulated energy changes as a result of this activity.

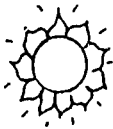
# What Makes It Move, Heat, Shine or Grow?

Name \_\_\_\_\_

ENERGY USERS									
Clock									
Hamburger									
T.V.									
Stove									
Furnace									
Radio									
Flash-light									
Lamp									
Refrig.									
Water Heater									
Tree									
Sail-boat									
You									
Car									
Grill									
Puppy									

Each of the items named above need energy to make it move - heat up - shine - or grow! Place an "X" in the column under the form of energy that powers each energy user. Some of the users run on more than one type of energy.

## PRIMARY ENERGY SOURCES

Coal: Today, coal is our most abundant fossil fuel, but it ranks only third as a supplier of energy. It is not widely used due to the cost of mining and its impurities which cause pollution. There are two ways of mining coal; underground mining and strip mining. New ways of using coal are being explored, such as liquification, in which a product similar to oil is produced.

Geothermal: Geothermal energy refers to the energy in fountains of boiling water and steam known as geysers. This energy source is very popular in Iceland, New Zealand, and Japan, where geysers are common. It is used to heat some homes, greenhouses, and factories. The actual usable geothermal sites are few.

Hydroelectric: When water is collected behind dams on large rivers, it provides a source of energy for the production of electricity. The enormous power of falling water is capable of turning giant turbines. These turbines drive the generators which produce electricity. The degree of power is determined by the amount of water and the distance it falls.

Natural Gas: Do not confuse natural gas with gasoline, the fuel used in automobiles. They are not the same! Natural gas comes to our homes in pipelines and it is widely used as an energy source for home heating, cooking, washing and drying. It is also used as a raw material in the production of petrochemicals. The major use today is to supply industrial heat.

Nuclear Fission: In the 1930's, scientists found that splitting the nucleus of an atom releases a tremendous amount of energy. This knowledge was used to make atom bombs. Today, power companies use the heat produced by nuclear fission to produce electricity. Some people think nuclear energy should be our main source of future energy. Other people feel that the dangers are too great from radioactive waste products, meltdowns, and radiation exposure of workers.

Petroleum: The first oil well was drilled in 1859 in Titusville, Pennsylvania. Until that time, oil had been known and used for thousands of years for lighting, cooking and water proofing of ships. Today, more than fifty percent of the petroleum consumed in this country is for transportation. Products made from petrochemicals today include synthetic rubber, detergents, fertilizers, textiles and paints. It is also widely used for home heating and as a fuel for electric power plants.

Solar: Even though the sun is 93,000,000 miles away, this ball of hot gases is the primary source of all energy on earth. Without sunlight, fossil fuels could never have existed. The sun is the supplier of energy which runs the water cycle. The uneven heating of the earth produces wind energy. Solar energy can be used to cook food, heat water and generate electricity and remains the cleanest energy source and it is renewable. It is truly the hope for the energy source of the future!

Wind: The unequal heating of the earth's surface by the sun produces wind energy which can be converted into mechanical and electrical energy. For a long time, the energy of wind has been used to drive pumps. Today windmills can be connected to electric generators to turn the wind's motion energy into electrical energy. Any wind over 8 miles per hour can be used to generate electricity. It is estimated that the wind will produce 1% to 15% of our electrical needs by the year 1995.

Wood: Wood provides U.S. homes and industries as much power as nuclear plants. Burning is the major global source of carbon monoxide in the atmosphere. Worldwide, wood is poor man's oil, providing 50 to 60% of the people with the barest energy necessities. Roughly half of the earth's forests have disappeared since 1950.

Name \_\_\_\_\_

# Primary Energy Sources

Label each energy source.

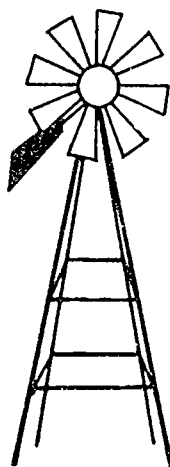
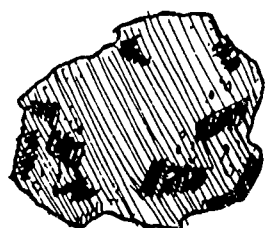
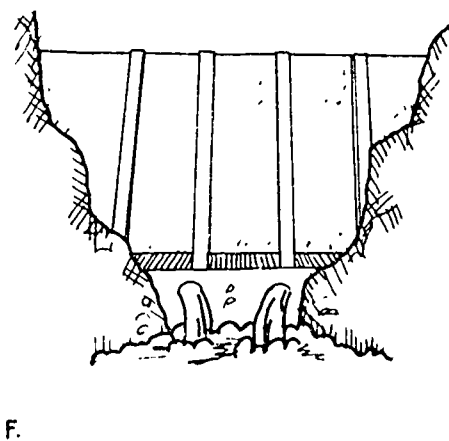
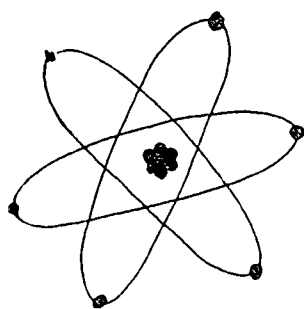
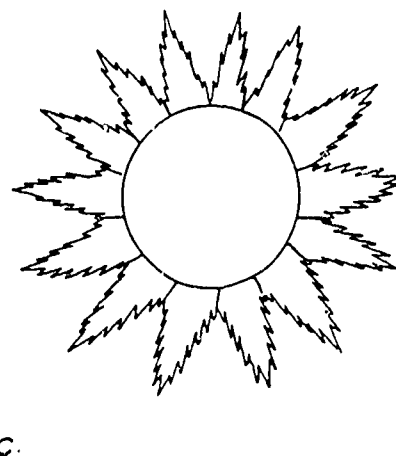
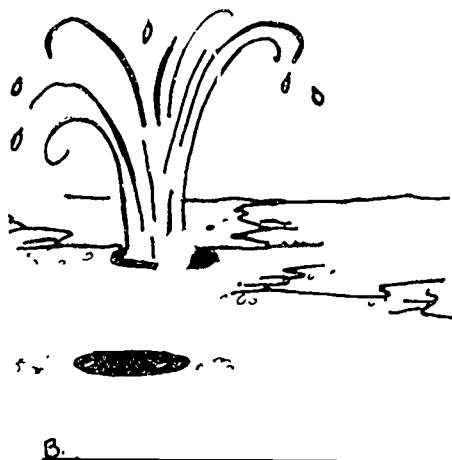
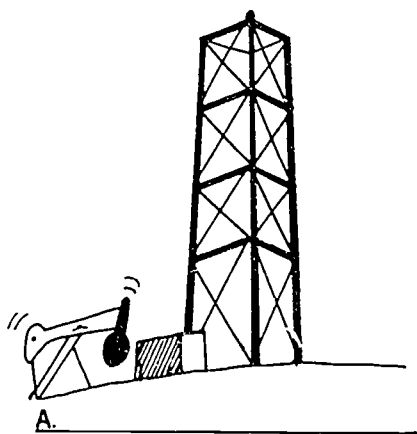



THE ENERGY SOURCE GAME

1. More than 50% of this energy source is used for transportation.

 Putt, putt!  
Now get the lead out and go to #2.

2. The primary source of all energy is the \_\_\_\_\_

You are solarific! Go to #3.

3. Heat from geysers is called \_\_\_\_\_ energy.

Don't blow up like "Old Faithful"! Ready for some more? Just move on to #4.

4. This black rock burns but watch out for the smoke!

Acid rain drops may fall on your head. Better jive over to five.

12. This energy source is now used to make plastic, rubber, paint and fertilizer. Be the first to guess it.

\_\_\_\_\_ The Oily Bird catches the word.

Draw the primary energy source symbols in this box.

5. Many people in the world still use this for heat. Would you believe it's renewable?

Don't munch around the campfire! Get done with your marshmallow sticks and move to #6.

11. This energy happens around dams where water moves very fast.

One more to go; so let's delve into #12.

6. Watch out for straying electrons as the atom is split!

There could be some con"fusion" in heaven; better move to #7.

10. This one could burn you if you stay out in it too long.

Go back and check seven; now move to #11.

9. This one should be a breeze; see if you can guess what it takes for this energy to produce electricity.

Don't blow too hard on the mill; take you pen to #10.

8. This started in 1821, Now we use it in homes and factories to "feel the heat"

Wasn't that a gas? Fine, let's move to #9.

7. The electricity created at large waterfalls is \_\_\_\_\_

Don't get soggy; it's getting late. Move on to #8.

TITLE GO WITH THE FLOW

---

SUBJECT Science

LEVEL Intermediate

---

#### ACTIVITY IN BRIEF

The student will create machines to do work using several kinds of energy.

---

#### OBJECTIVE

Each student will be able to identify several kinds of energy.

---

#### MATERIALS

paper  
handouts (2a, 2b)  
large box labeled "200 pounds"

#### LEVEL

awareness - 15 minutes  
development - 20 minutes  
application

---

#### LEARNING CYCLE

**AWARENESS** - The students are told they have 15 minutes to come up with as many different plans as they can to get a box (weighing 200 pounds) into the back of a truck five feet from the ground. They may work with a partner. Plans must be drawn out on paper. Each team will present their plans to the class.

**CONCEPT DEVELOPMENT** - The students read from the board the definition of energy. "Energy is the ability to do work. Anything in a state of movement demonstrates kinetic energy. Anything in a position where it can move represents potential energy. The students make a list of kinds of energy. What can cause something to move, light up, or heat up? (Remind the students that sound, light, heat, and electricity all cause molecules, atoms or electrons to move.) Give them "Energy at Work" (I-2a).

**APPLICATION** - The student will work the Simplified Pencil Sharpener model (see I-2b) and then draw up plans for a simplified machine using at least five different kinds of energy. Some may actually be possible to make.

**EVALUATION** - The student will explain the kinds of energy used in the model created in the application.

---

#### FOLLOW-UP/BACKGROUND INFORMATION

There are two forms of energy - potential and kinetic. Potential (stored energy is the energy an object has before it does work, such as a wound-up toy, a ball at the top of a slope, the water at the top of the falls, etc. Kinetic energy is energy in motion. Any object in motion has kinetic energy. The wind, an electric current, the sound of the guitar strings vibrating, and electricity flowing through the light bulb are forms of kinetic energy. Some kinds of energy are heat, light, chemical, sound, mechanical, and electricity. Heat is the mechanical energy of molecules in motion.

Sound causes air molecules to move, which in turn causes our ear drums to vibrate causing us to hear.

Light from the sun creates a chemical reaction in green plants converting light energy to simple sugars in a process called photosynthesis. A solar cell is an example of light energy being utilized.

Chemical energy can be observed in a flashlight battery (i.e. chemical energy converting to light). A human body is an example of chemical energy (the muscle cells using sugar).

Mechanical energy is the movement by a machine or body part.

Electricity is the flow of electrons through a conductor.

#### SOURCE OF ACTIVITY

Simplified Pencil Sharpener adapted from Inventor's Workshop.

# Model of a Simplified Pencil Sharpener

Name \_\_\_\_\_

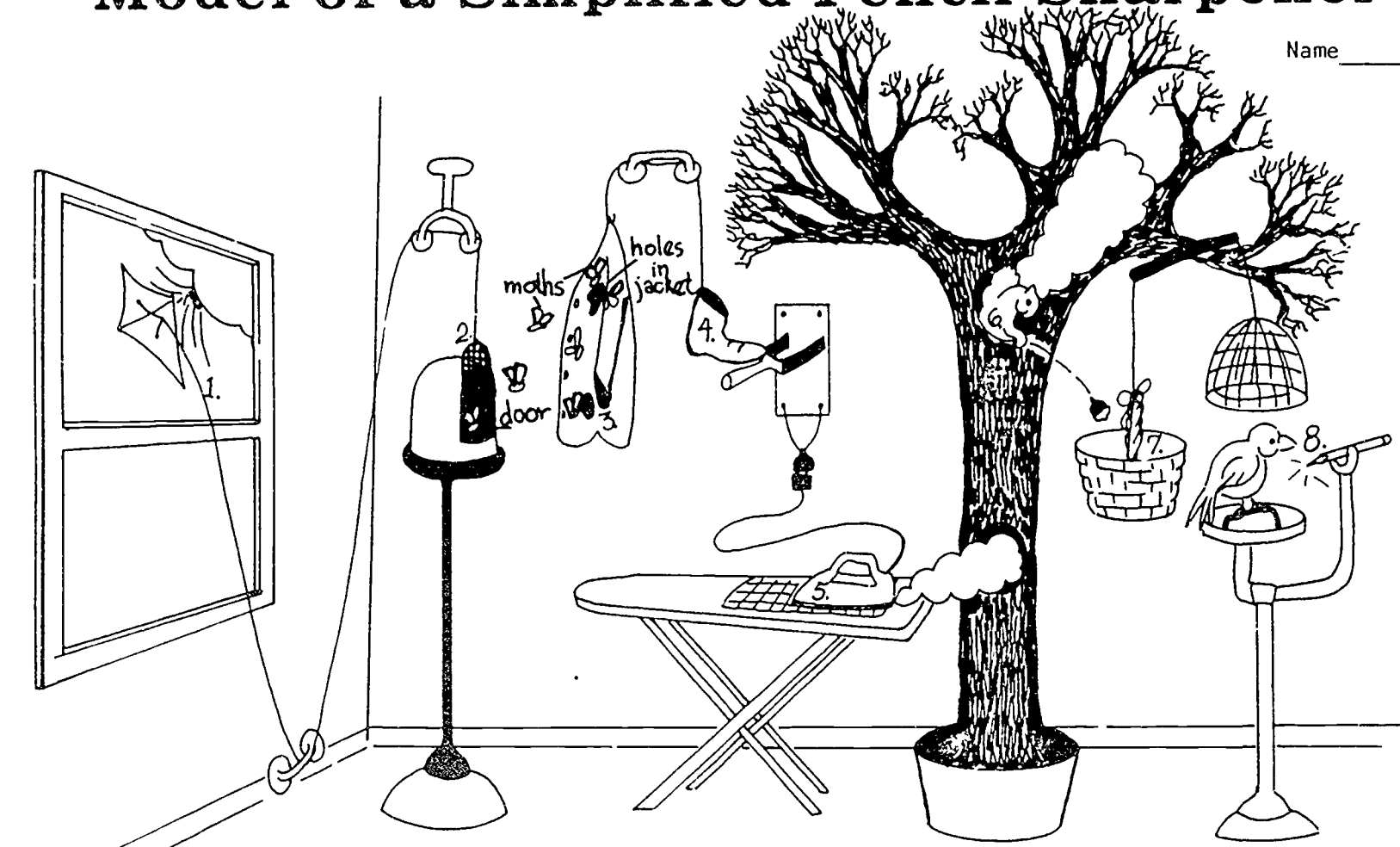

Tell what is happening at each step. Name the energy form being used.

- | Energy Form                                 | Energy Form |
|---------------------------------------------|-------------|
| 1. _____                                    | 5. _____    |
| 2. _____                                    | 6. _____    |
| 3. <u>Moths chewing holes</u> <u>Muscle</u> | 7. _____    |
| 4. _____                                    | 8. _____    |

Moving Molecules

Electricity

Falling Body

Heat

Muscle

# Energy at Work

Label the kind of energy being used in each picture below.

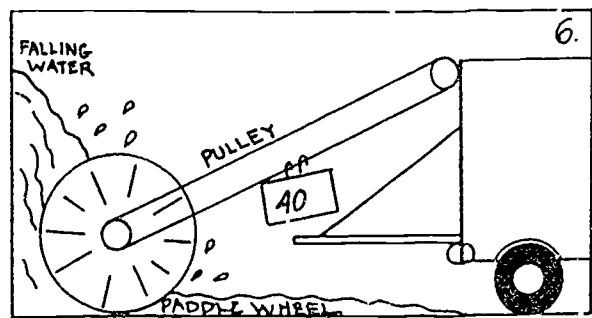
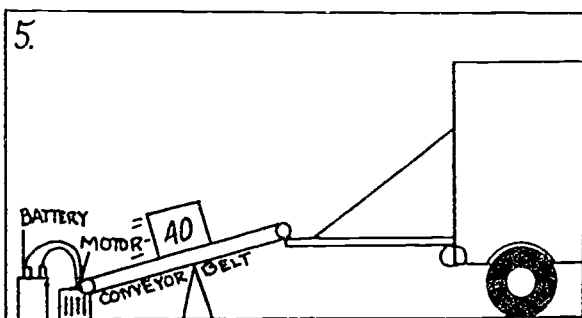
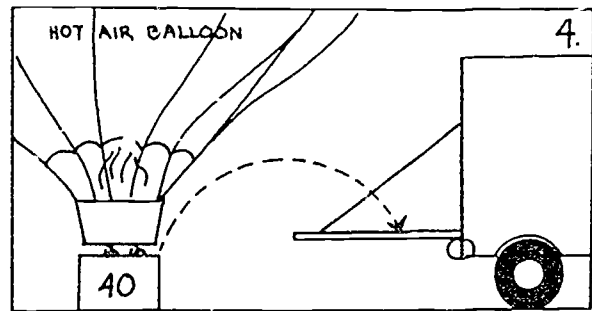
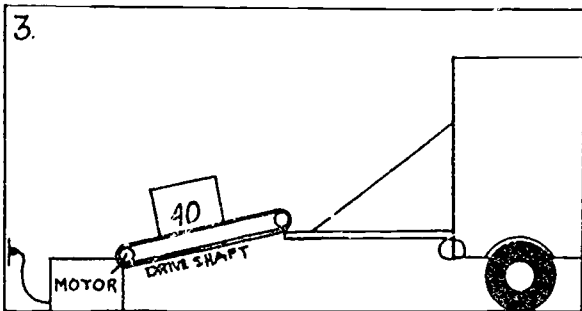
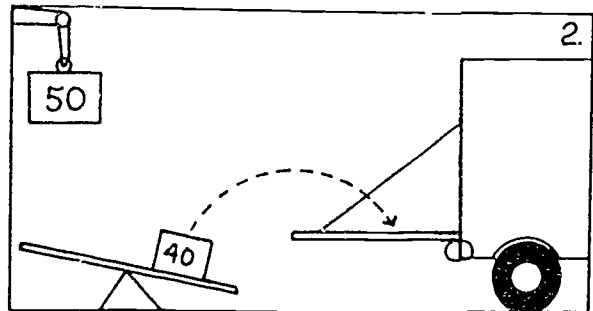
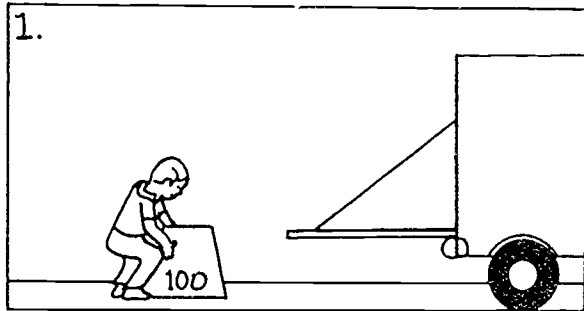

Electricity

Chemical

Mechanical

Light

22

Heat

Mechanical

**TITLE** My, How You've Changed

---

**SUBJECT** Science, Reading

**LEVEL** Intermediate

---

**ACTIVITY IN BRIEF**

Students will watch for chemical changes in plant matter (decaying leaves, a banana peel turning brown, and wood changing to charcoal). They will describe how coal, petroleum, and natural gas were formed millions of years ago.

---

**OBJECTIVE**

Each student will be able to tell the fossil fuel formation story.

---

**MATERIALS**

handouts - I-3a, I-3b  
 experiment materials - see I-3a  
 lump of coal  
 banana peel  
 soil in a can - paper

**TIME**

awareness - 30-45 minutes  
 concept development - 20 minutes  
 application - 60 minutes

---

**LEARNING CYCLE**

**AWARENESS** - Students discuss what happens to plants (leaves, trees, etc.) after they die and fall to the earth. Concrete examples of a rotting log, decaying leaves, etc., might be shown. Cover a banana peel and observe the changes. Do the experiment with wood changing to coal. (See 3a)

**CONCEPT DEVELOPMENT** - Students are shown a lump of coal. They are told that it was once plant parts or material. Students will describe how they think coal is formed in the earth. The children look at the picture and read the fossil fuel formation story. (See I-3b - "Millions of Years Ago")

**APPLICATION** - Students create a class diorama showing what the earth might have looked like during the period when fossil fuels were formed.

**EVALUATION** - Students tell in a paragraph or with pictures "The Story of My Life" as told by a lump of coal.

---

**FOLLOW-UP/BACKGROUND INFORMATION**

It should be stressed that we are currently using fossil fuel resources a million times faster than the natural systems can produce them. The students would enjoy opening up coal and searching for leaf imprints and other fossil remains.

**SOURCE OF ACTIVITY**

Adapted from Watt's Happening

## Mini-Charcoal Maker

1. Collect these materials:
  - tin can with foil cover (with a pinhole in it)
  - portable camp stove
  - wood shavings
  - potholder
  - matches
2. Put the wood shavings in the can. Cover the can with the foil.
3. Put the can on the stove; turn the stove on medium heat.
4. Watch the smoke being driven from the wood by the heat.
5. Light the gas escaping from the pinhole.
6. Keep heating the can, until the flame goes out completely and cannot be lit again.
7. After the can has cooled, remove the lid. You will find pieces of black CHARCOAL inside. (Charcoal is almost pure carbon)
8. Light the charcoal and see how it burns.

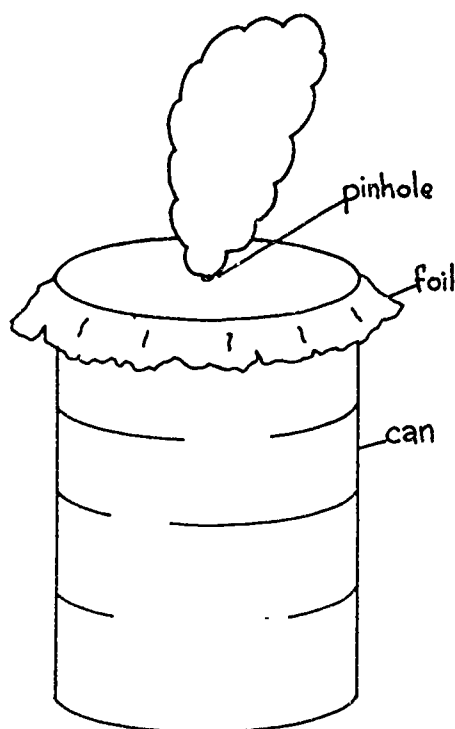



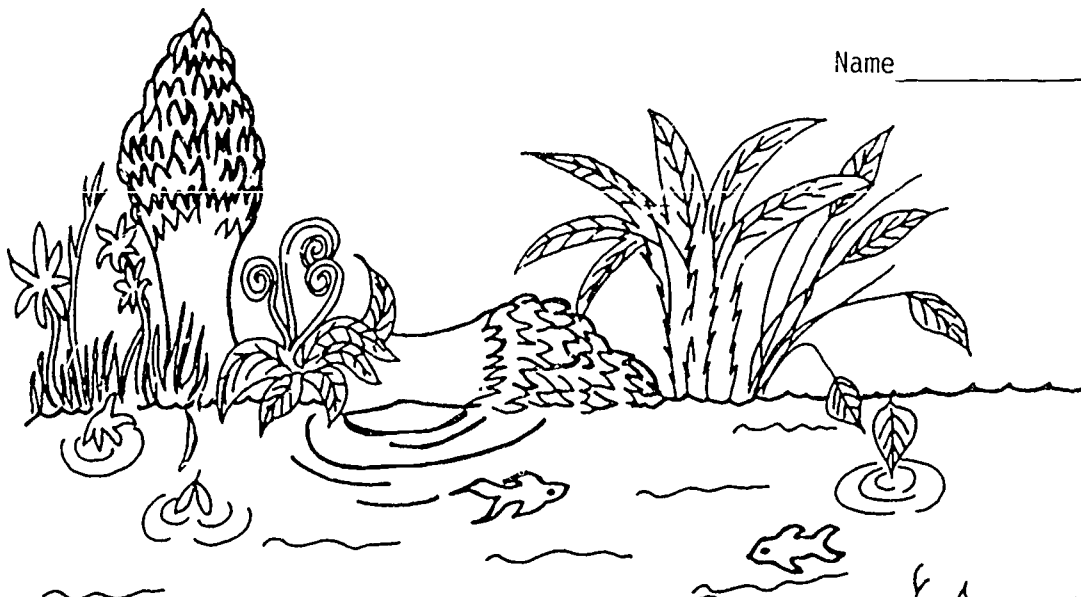

Millions of Years ago....



most of the U.S.A. was a swamp with large ferns and other unusual plants and animals. When they died, the plants and critters sank to the bottom of the swamp. Hundreds and hundreds of years went by and the dead plants and animals got covered with mud and sand. The swamps dried up and the mud, sand, rock, and soil pressed and pressed and pressed and pressed and pressed and squeezed and squeezed and squeezed all those dead, decaying, rotting, squishy, oozy plants and animals and changed them into coal, petroleum, and natural gas!!

Number the pictures below in the proper order.

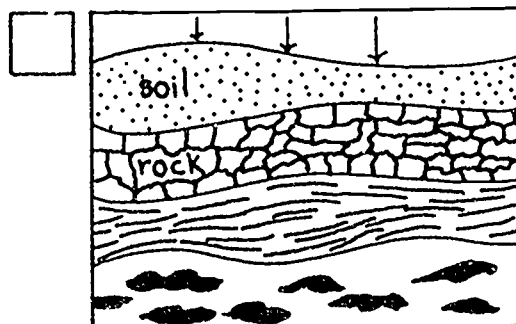
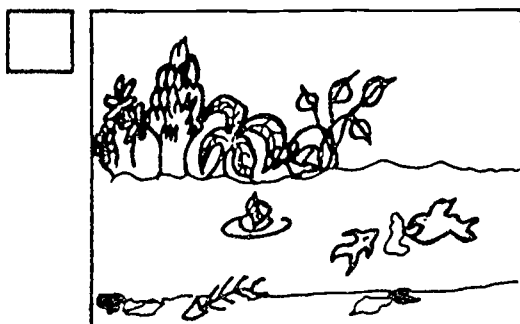
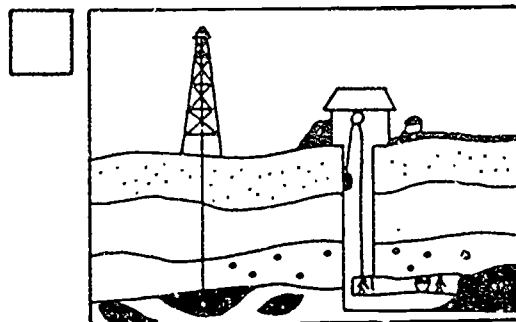
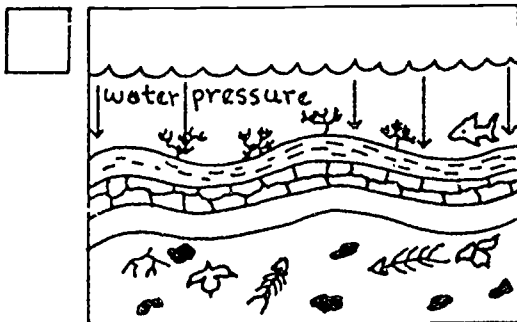

TITLE Dig It

---

SUBJECT Social Studies, Reading,  
Art, Writing

LEVEL Intermediate

---

#### ACTIVITY IN BRIEF

Each students will predict and extract chocolate chips found in a chocolate chip cookie. They will make a list of pros and cons of underground and strip mining.

---

#### OBJECTIVE

Each student will be able to

- describe the 2 kinds of mining (strip and underground).
  - state advantages and disadvantages of mining and using coal.
  - map where the coal reserves are in Iowa and in the U.S.A.
- 

#### MATERIALS

chocolate chip cookies  
napkin for each student  
handouts I4a, b, c, d, and f

#### TIME

Awareness - 30 to 45 min.  
Concept Development - 1 to 2 hours  
Application - 2 sessions of  
45 to 60 minutes each

---

#### LEARNING CYCLE

**AWARENESS** - Students are presented with a chocolate chip cookie placed upon a napkin before them. They are instructed that each chip represents a coal deposit. They visually observe and predict the number of chips in the cookie on their napkin. They are instructed to mine the cookie and extract the chips. They compare the number removed with their prediction. Students then observe what they did to their "environment". Now they will plan more carefully the environmental impact upon the land, their cookie. They are then given a second cookie and instructed to make their prediction and to do their mining with minimal damage to their land. Students' predictions for each mined cookie are charted on the chalkboard.

**CONCEPT DEVELOPMENT** - A picture is shown of both mining techniques (see I4a). Statements relating to coal mining are read, and the student determines if each is a disadvantage or an advantage. They will find where they live on coal distribution maps (I4b, I4c). The students will look at the picture (I4d) and talk about the causes and effects of ACID RAIN. The students will color the picture (They are encouraged to add to the picture). Do experiment (I-4f) to demonstrate the effects of chemicals in the air.

APPLICATION - Students do the "What's on Your Mind" activity (see I-4e). A mock town meeting is held to hear the various views regarding the mining of a known coal reserve outside the town. Committees are formed of representatives of each faction (doctors, naturalists, citizens, miners, teachers, machine operators, "wildlife"). Each group gathers its "ammunition" and elects a speaker to represent the group at the council meeting. The city "council", after hearing all the viewpoints, must agree on a plan regarding what regulations must be applied if and when mining begins. (see Background Information)

EVALUATION - The students will draw a picture of the two kinds of mining and state three advantages and three disadvantages of coal mining.

---

#### FOLLOW-UP/BACKGROUND INFORMATION

An excellent film on Iowa coal-mining is called The Last Pony Mine, available from the Area Education Agency.

#### SOURCE OF ACTIVITY

Adapted from Outlook

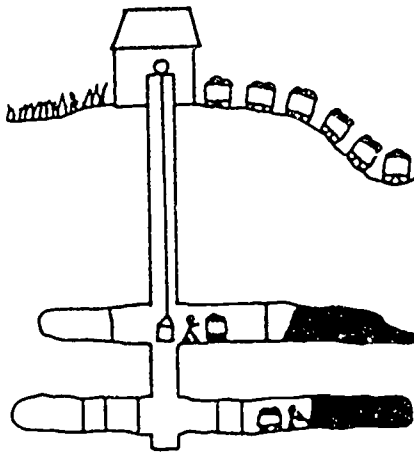
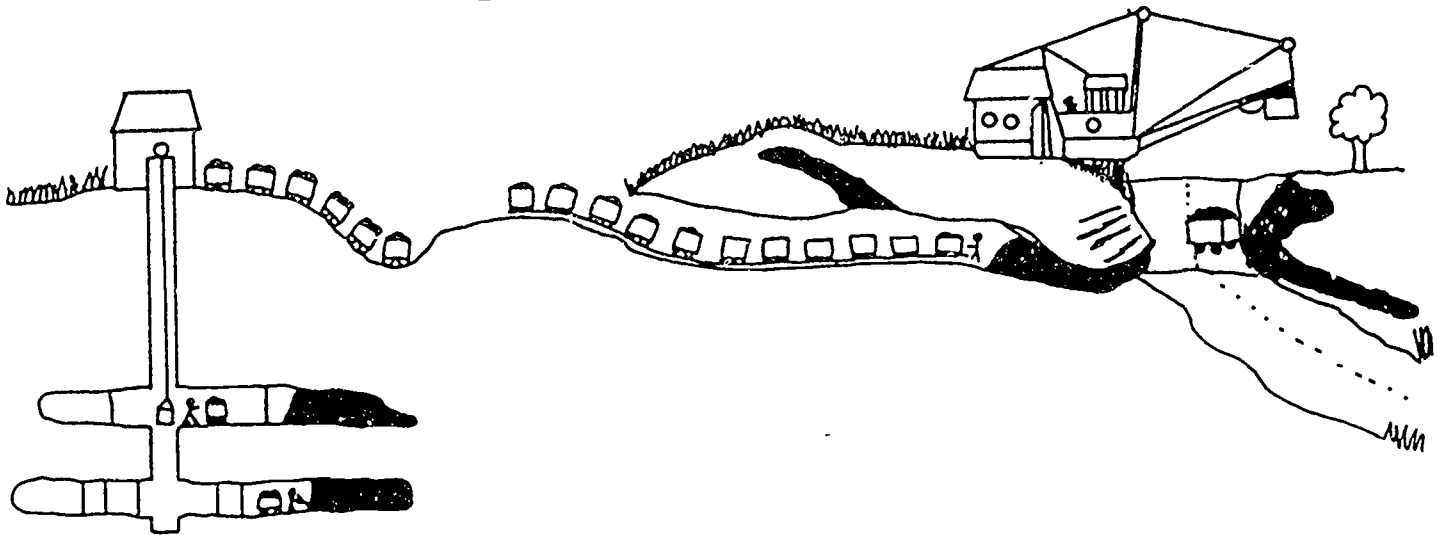
**DIG IT!****Underground Mining****Strip Mining**

- Coal will eventually run out.
- Underground mines can cause black lung disease.
- Coal can help make electricity.
- Mining provides jobs.
- The burning of coal causes air pollution and contributes to acid rain.
- There is more coal left than there is oil or natural gas.
- Strip mining can damage the environment.

Advantages of Coal MiningDisadvantages of Coal Mining

# U.S. COAL SUPPLY LOCATIONS

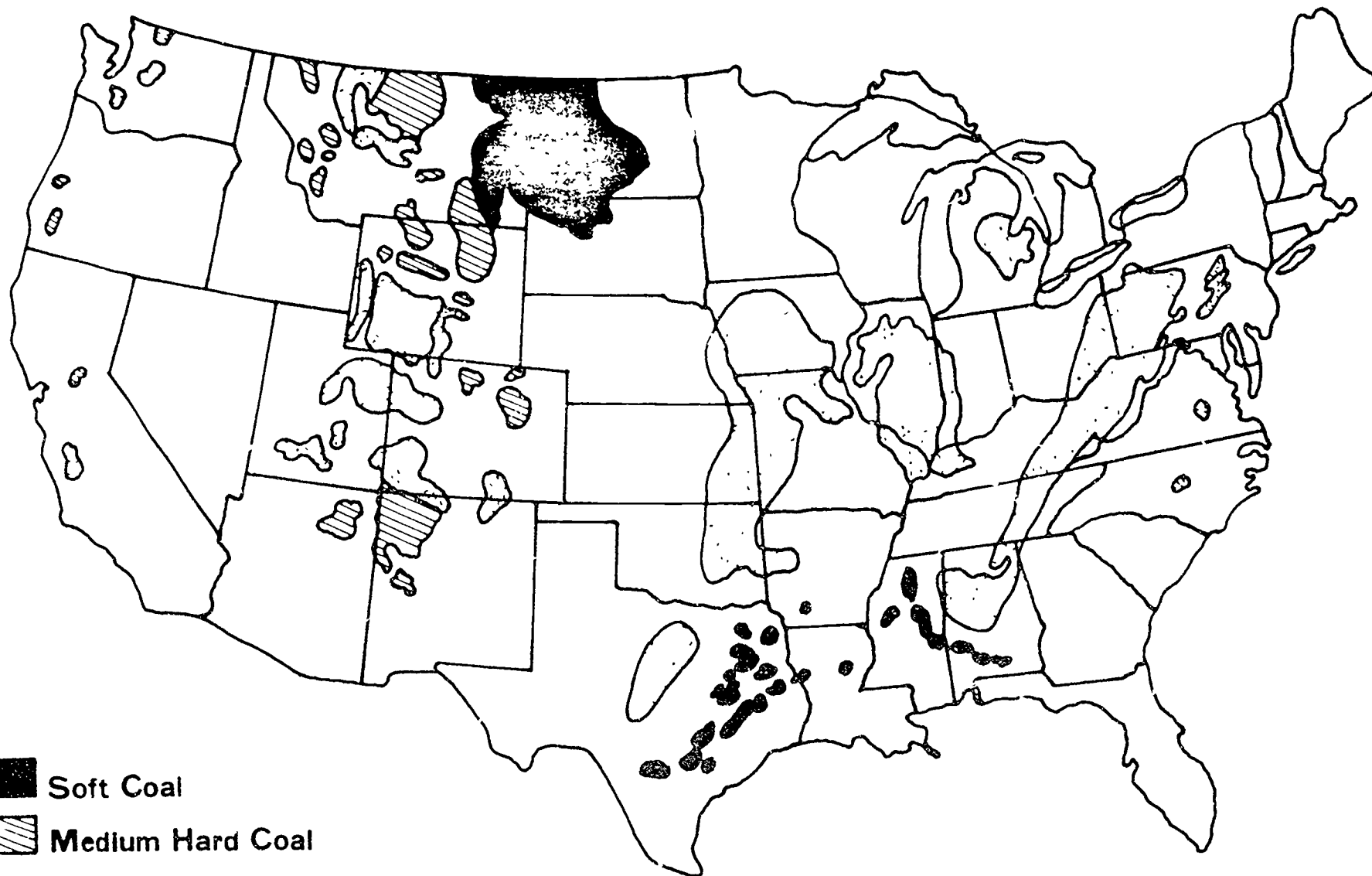

- Soft Coal
- ▨ Medium Hard Coal
- Hard Coal

# IOWA COAL MINES

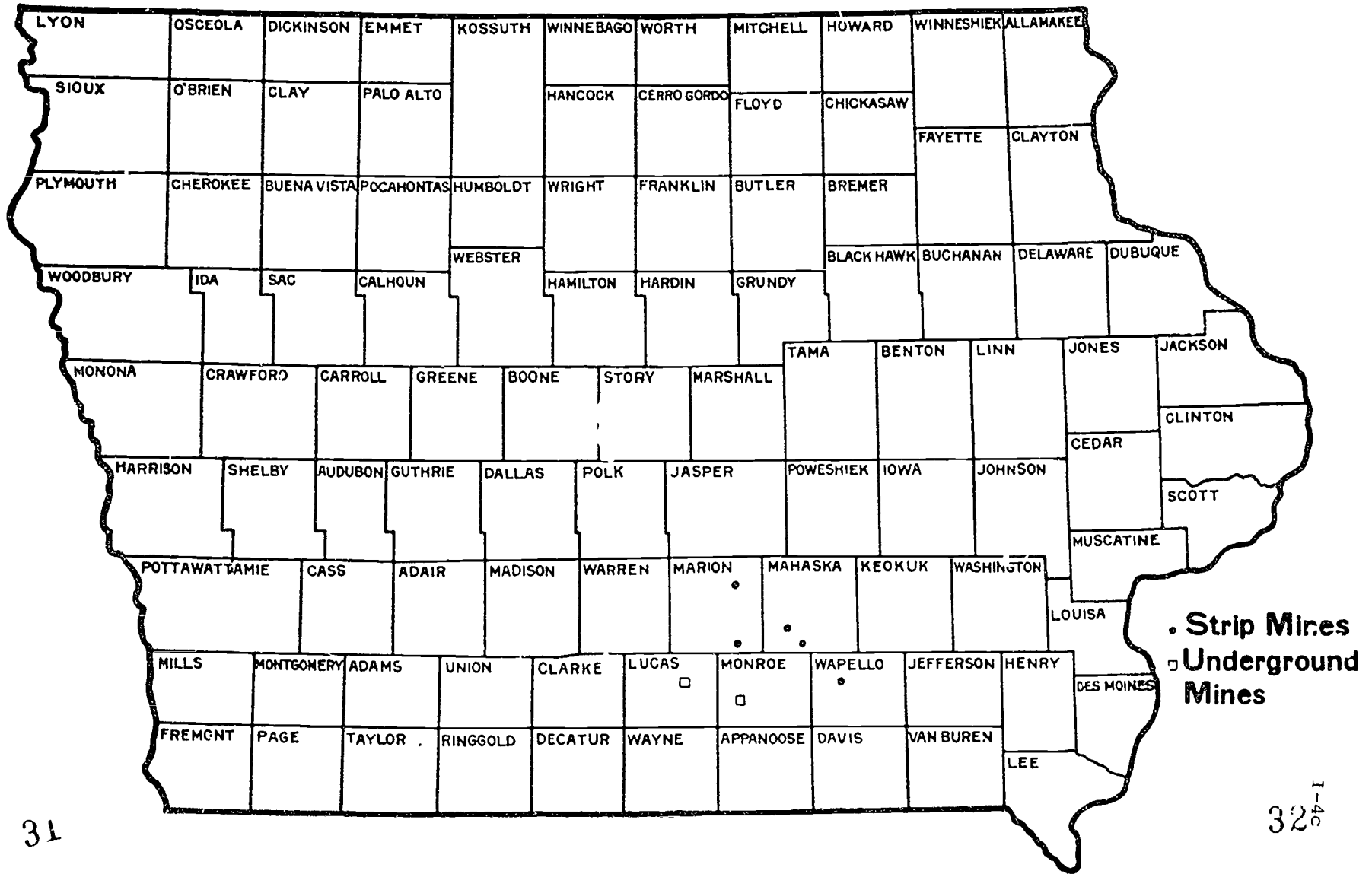

# WHAT'S ON YOUR MIND

What do you think about coal mining ??

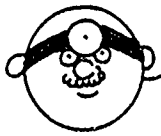

doctor



naturalist

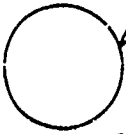

you

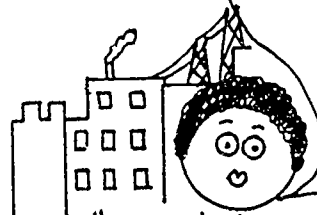

citizen living close to a power plant using coal

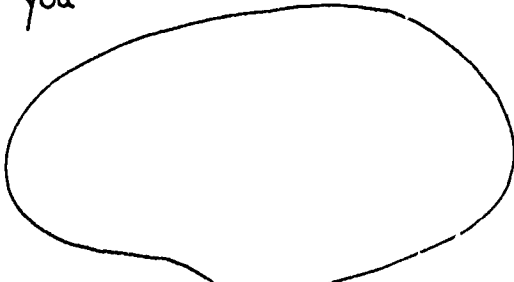

native American



miner

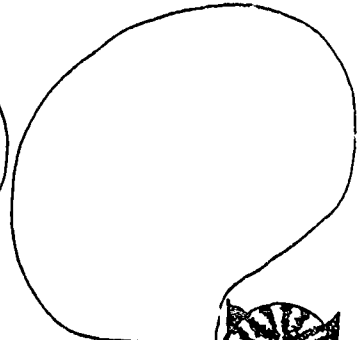

deer, squirrel, "wild life"

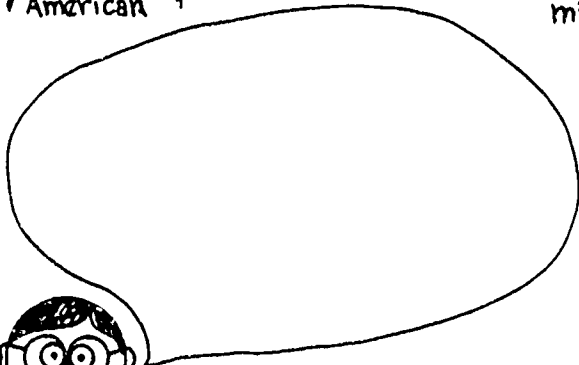

teacher

33

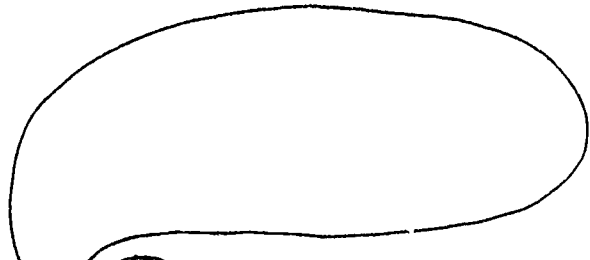

machine operator



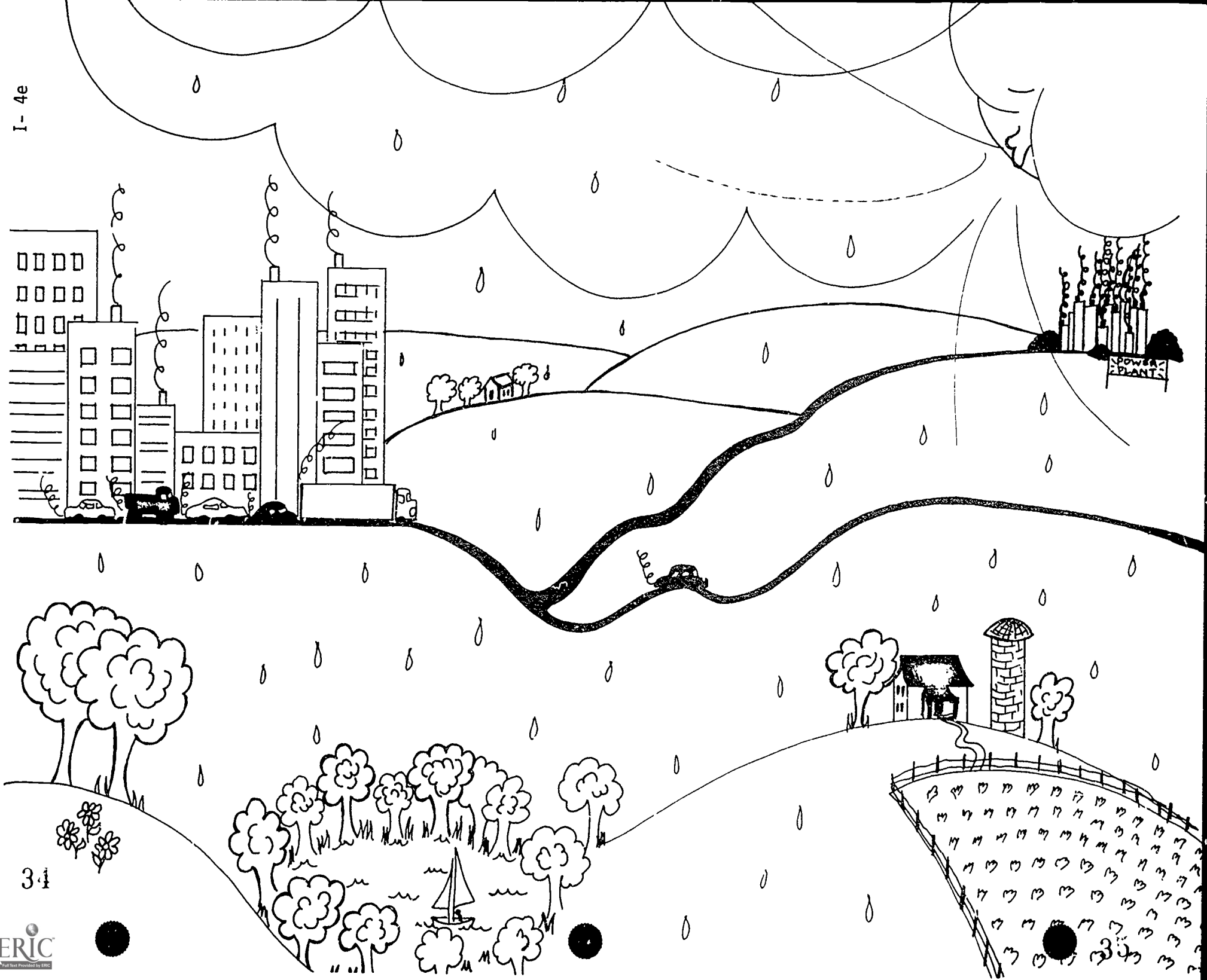

POWER PLANTS

## THE EFFECTS OF AIR POLLUTION!

Air pollution is a problem in areas where large industries burn fossil fuels, such as coal. Coal releases large amounts of sulfur into the air when it is burned. Sulfur in the atmosphere is easily joined to oxygen and water vapor to form many dangerous pollutants such as sulfuric acid. Sulfuric acid and other sulfur compounds can easily damage paint, metals, rocks, paper, and fabrics, as well as vegetation and animal life.

To show how fabrics are attacked by pollutants, set up the following experiment:

**Materials:** Wide mouth jar, magnifying glass, rubber bands or string, nylon stocking, scissors, tailpipe and cheesecloth

**Procedure:** Cut out an undamaged section of the nylon stocking and stretch it over the mouth of the jar. Fasten it with rubber bands or string. Use a magnifying glass to check the stocking for damage. Set the jar outside in an open spot. Allow the jar to remain outside for a month. Examine it again for damage or breaks. If the stocking shows no breaks, it may indicate little chemical pollution. More than six breaks indicates heavy chemical pollution.

To observe the particulants put into the air from an automobile, cut out a piece of cheese cloth and rubber band it over a car's tailpipe. Have an adult turn on the car for a short time (less than a minute). Be sure the tailpipe is cool and then remove and examine the cheesecloth. Compare the effects from several different cars.

Should companies have car emission control laws?

**TITLE** Petroleum Pets

**SUBJECT** Science, Art

**LEVEL** Intermediate

**ACTIVITY IN BRIEF**

Students will find their way through a maze and discover things along the way which are made of petroleum. They will make "petroleum pets".

**OBJECTIVE**

The student will identify petroleum based items.

**MATERIALS**

handouts I5a, I5b, I5c, I5d  
 items from Home  
 plastic 1 gallon milk container  
 PCV pipe, clear plastic, comb, etc.  
 paper plates  
 fasteners  
 candle or burner  
 heavy duty foil

**TIME**

Awareness - 15 to 30 min.  
 Concept Development-30-60 min.  
 Application - Variable

**LEARNING CYCLE**

**AWARENESS** - The students will follow the maze (see 5a). Then they will turn the paper over and write down all the items they can from memory. The teacher will explain that each item shares one common ingredient - petroleum.

**CONCEPT DEVELOPMENT** - The teacher will display a number of petroleum-based products (see list 5-b for ideas) and the students will categorize them according to various features. The students will read the labels on clothing articles and identify the petroleum-based fabrics. The students will record the results of the burning test (see 5-c) as the teacher demonstrates and then the students will conduct and record their own floating (density) test.

**Materials:** pieces of various kinds of plastics, a large bowl of water

**Procedure:** place a piece of each kind of plastic in the water and record the results.

<u>Plastic from:</u>	<u>floats</u>	<u>sinks</u>
<u>milk jug</u>		
<u>PCV pipe</u>		
<u>clear plastic</u>		
<u>etc.</u>		

Read and complete 5-d.

APPLICATION - The students are to make "petroleum pets" at home to be brought to the Petroleum Pet show on a designated day. The "pet" should be constructed using only petroleum products. Encourage the utilization of as many petroleum products as possible for this activity. They could be paraded around the other classrooms as an appeal for conservation to petroleum-made products.

EVALUATION - Each student will list twenty petroleum based items essential for daily living.

---

#### FOLLOW-UP/BACKGROUND INFORMATION

Safety precautions should be reviewed for the burning test and this may be best achieved as a teacher-directed activity. Heavy duty aluminum foil over a table top should be used for any burning droplet that falls to the surface. A noncombustible top such as a cookie sheet may be used if foil is not available. When burning the oil based products use tongs to hold only a small sample to the flame. One should do so under an inverted beaker, because from styrofoam and some other plastic products, poisonous gases may be emitted. Keep good ventilation in the room.

A review of page 5a and 5b will list numerous items that are petroleum based. Many fabrics are comprised of petroleum products and practically all clothing articles have some petroleum materials.

#### SOURCE OF ACTIVITY

Janey Swartz

# OIL A-MAZE-MENT

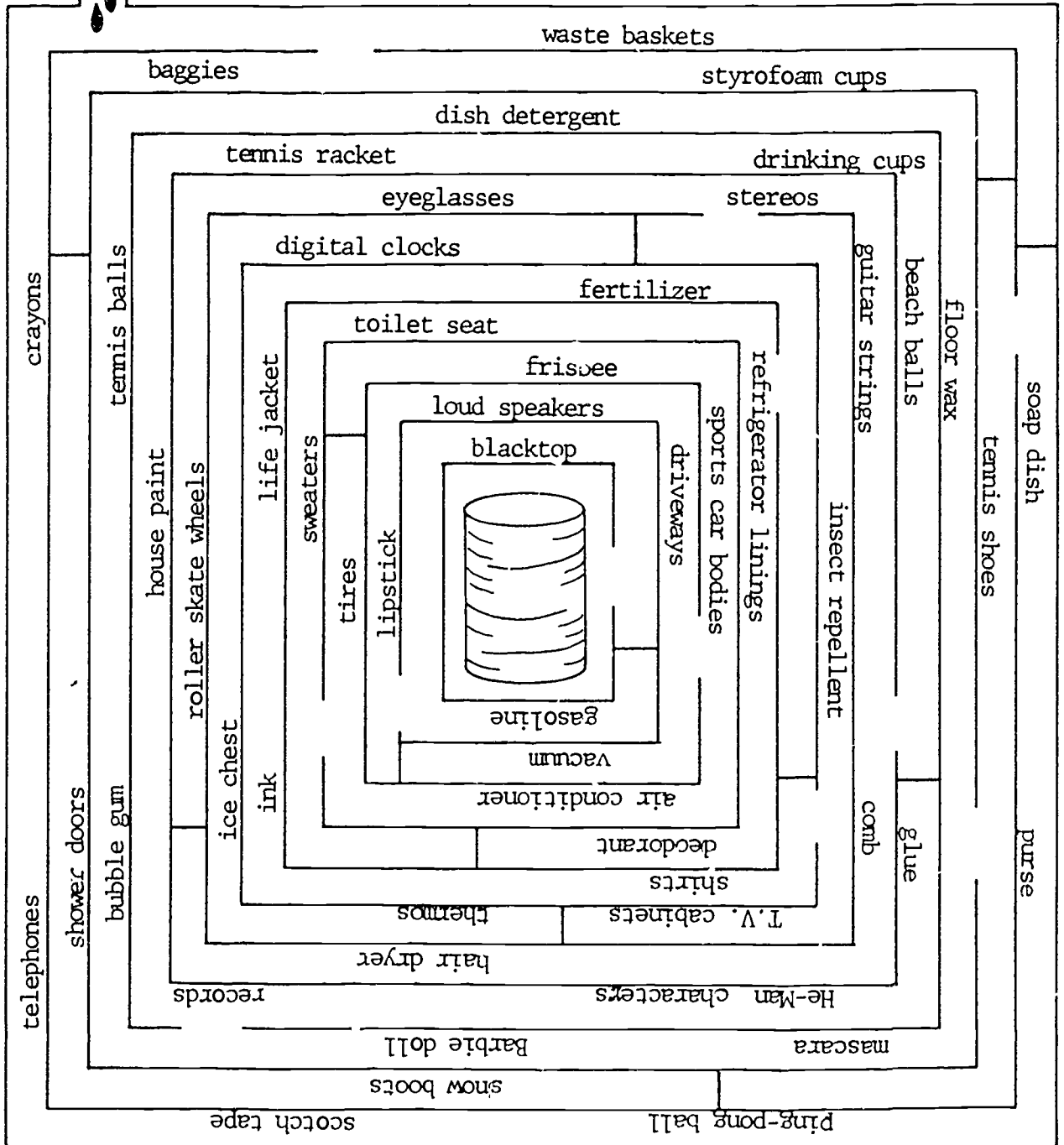

# Petroleum Products

**Ink**  
**Heart valves**  
**Parachutes**  
**Stretch pants**  
**Telephones**  
**Brassieres**  
**Enamel**  
**Transparent tape**  
**Antiseptics**  
**Vacuum bottles**  
**Ping-pong paddles**  
**Purses**  
**Planters**  
**Deodorant**  
**Air conditioners**  
**Crayons**



**Dolls**  
**Bubble gum**  
**Floor polish**  
**Sports car bodies**  
**Tennis balls**  
**Tires**

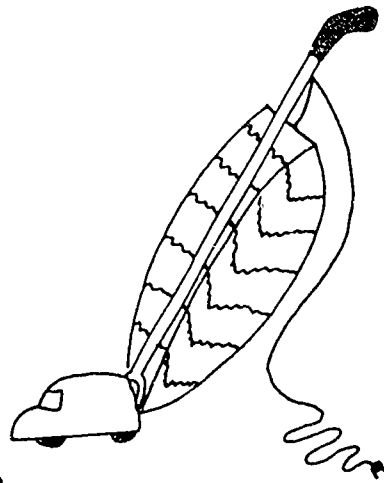

**Carpet sweepers**  
**Shower doors**  
**Soap dishes**  
**Slip covers**  
**Shoes**  
**Volleyballs**  
**Tobacco pouches**  
**Refrigerator linings**  
**Electrician's tape**  
**Model cars**  
**Folding doors**  
**Floor wax**  
**Mascara**  
**Sweaters**  
**Sneakers**



**Electric blankets**  
**Tennis rackets**

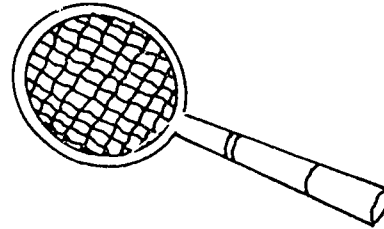

**Drinking cups**  
**Housepaint**  
**Rollerskate wheels**  
**Hair dryers**  
**Guitar strings**  
**Ammonia**  
**Eyeglasses**



**Digital clocks**  
**Life jackets**  
**TV cabinets**  
**Car battery cases**  
**Insect repellent**  
**Ice buckets**  
**Fertilizers**  
**Hair coloring**  
**Toilet seats**  
**Denture adhesive**  
**Frisbees**  
**Loudspeakers**



Name \_\_\_\_\_

We live in a world of plastics. Look around you! You will see clothes, shoes, desks, wallets, and many other things made mostly of plastic. Look up the word plastic in the dictionary. What does it mean? \_\_\_\_\_

From what Greek word does it come? \_\_\_\_\_

The three major types of plastics we use daily are polyethylene, polystyrene, and polyvinyl chloride. Polyethylene burns with a blue and yellow flame. It drips when it burns and smells like wax. It continues to burn when it is removed from the flame. It floats in water. Example: milk jug.

Other examples: \_\_\_\_\_  
\_\_\_\_\_

Polystyrene burns with a yellow flame. It drips when it burns and has an odor similar to gas. It continues to burn when it is removed from the flame. It does not float. Example: clear plastic from a pop bottle.

Other examples: \_\_\_\_\_  
\_\_\_\_\_

Polyvinyl chloride burns with a yellow and green flame. It does not drip and does not continue to burn when it is removed from the flame. It has a strong odor and it does not float. Example: PCV pipe.

Other examples: \_\_\_\_\_  
\_\_\_\_\_



**TITLE** The Petroleum Blues in the News

---

**SUBJECT** Language Arts

**LEVEL** Intermediate

---

**ACTIVITY IN BRIEF**

Students will observe the effects on the world's energy reserves as they utilize petroleum in their daily living.

---

**OBJECTIVE**

The student will be able to list ways to conserve petroleum.

---

**MATERIALS**

handouts (6a, 6b, 3b)  
containers (see Concept Development)  
glass bowl  
spoon, buckets

**TIME**

Awareness - 25 minutes  
Concept - 30 minutes  
Application - 25 minutes

---

**LEARNING CYCLE**

**AWARENESS** - A large glass bowl of water which is marked World's Supply of Petroleum is placed on a table (near a sink, if possible). The students will make a list of way petroleum products were used during the past day by themselves, their family, the school, and in their community. As each student tells how a petroleum product was used, someone designated to be the dipper, dips out a spoonful of "petroleum" and throws it down the drain (or into a container).

The students are divided into groups representing countries and are given dippers as listed:

U.S.A.	2 cup container	Mexico	1/4 c. container
France	2/3 cup container	China	1 Tablespoon
U.S.S.R.	1/2 cup container	Kenya	1 Thimble

(Each cup represents the proportional amount of petroleum consumed by that country each year.) As the teacher calls out the year (1988, 1989, etc.) one person from each country (group) dips out their allotment and throws it into a container that represents what has been used to date. (All discard containers should be the same size.) This continues until the supply is depleted. The students discuss possible reasons why the U.S.A consumes so much more petroleum than the other countries.

**CONCEPT DEVELOPMENT** - The students review I-3b and then read and work I-6a.

**APPLICATION** - The students make choices which conserve petroleum. (I-6b).

**EVALUATION** - The student lists fifteen ways petroleum or its products are used in daily living.

---

**FOLLOW-UP/BACKGROUND INFORMATION**

The U.S.A. represents 6% of the population and consumes 34% of the world's energy.

The U.S.A. consumes:

- 2 1/2 times as much energy as the USSR
- 3 times as much energy as France
- 4 times as much energy as Japan
- 10 times as much energy as Mexico
- 23 times as much energy as China
- 100 times as much energy as Kenya

Another way to show this is to hand out peanut M & Ms in clear plastic glasses, so that students can see concrete examples of energy consumption among the continents of the world. Students could represent the population of the various continents. The world consumes 80 quadrillion btu's of energy annually. We can state this as 80 quads, and each M & M may represent one quad for a total of 80 M & Ms. The class is divided proportionately allocating student numbers by continent population.

See Activity I-12 for distribution facts.



••••• = Oil producing areas

**SOURCE OF ACTIVITY**

Conservation for Children and Watt's Happening by Janey Swartz

## Bad News-The Petroleum Blues

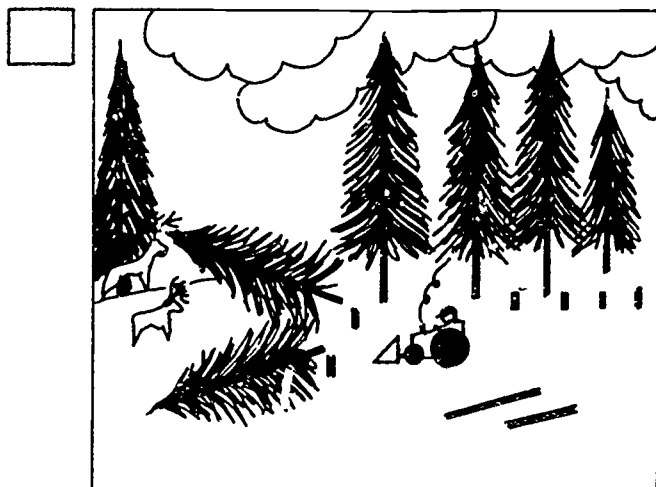
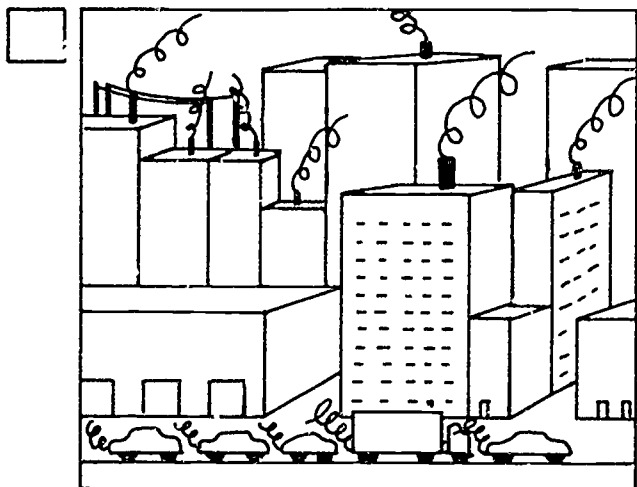
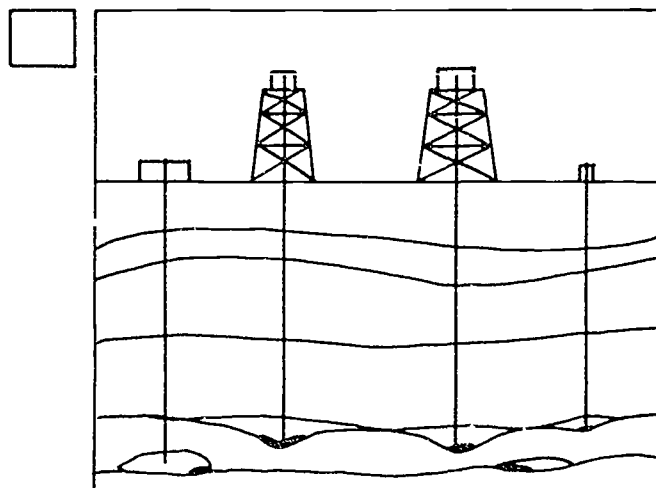
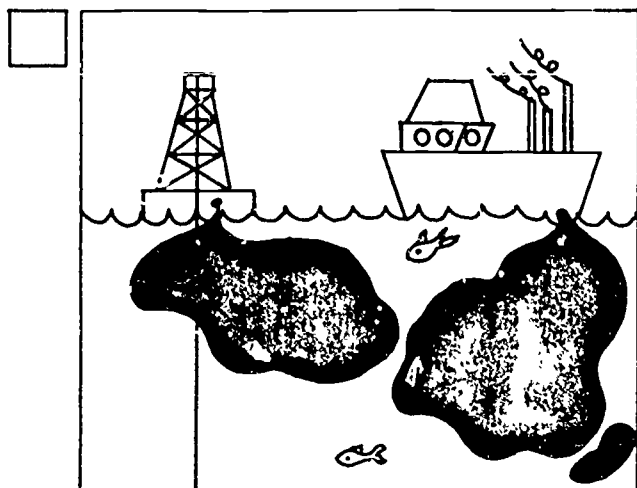

### Match the statement with the picture.

1. *Petroleum resources may be used up in just a few decades.*
2. *Burning petroleum or it s products causes pollution.*
3. *Sometimes spills occur whereby petroleum is spilled into the ocean or onto shorelines from off-shore wells or oil tankers.*
4. *Pipelines must sometimes be built across long distances, including undisturbed natural areas, to transport oil from oil fields.*

## WAYS TO CONSERVE PETROLEUM!

by \_\_\_\_\_  
(name)

Read each action. Think of a way to conserve or recycle petroleum products.  
(Petroleum is non-renewable. Paper and wood are renewable.)

Petroleum - EaterAlternative

- |                                                                                         |                                |
|-----------------------------------------------------------------------------------------|--------------------------------|
| <input type="checkbox"/> styrofoam cup - use once<br>and toss away                      | <input type="checkbox"/> _____ |
| <input type="checkbox"/> plastic picnic utensils                                        | <input type="checkbox"/> _____ |
| <input type="checkbox"/> plastic soda pop (bottle)<br>container                         | <input type="checkbox"/> _____ |
| <input type="checkbox"/> plastic sandwich bags                                          | <input type="checkbox"/> _____ |
| <input type="checkbox"/> plastic bags for fruits and<br>vegetables at the grocery store | <input type="checkbox"/> _____ |
| <input type="checkbox"/> plastic grocery bags                                           | <input type="checkbox"/> _____ |
| <input type="checkbox"/> plastic garbage bags                                           | <input type="checkbox"/> _____ |
| <input type="checkbox"/> drive car to store every time<br>something is needed           | <input type="checkbox"/> _____ |
| <input type="checkbox"/> drive car to mall                                              | <input type="checkbox"/> _____ |
| <input type="checkbox"/> bread wrapper after bread is gone                              | <input type="checkbox"/> _____ |
| <input type="checkbox"/> styrofoam picnic plates                                        | <input type="checkbox"/> _____ |
| <input type="checkbox"/> tires for cars and trucks                                      | <input type="checkbox"/> _____ |
| <input type="checkbox"/> toothpaste dispensers                                          | <input type="checkbox"/> _____ |
| <input type="checkbox"/> plastic soda straws                                            | <input type="checkbox"/> _____ |
| <input type="checkbox"/> plastic ice cream containers                                   | <input type="checkbox"/> _____ |
| <input type="checkbox"/> polyester clothes                                              | <input type="checkbox"/> _____ |
| <input type="checkbox"/> fertilizers and pesticides                                     | <input type="checkbox"/> _____ |
| <input type="checkbox"/> paints and lacquers                                            | <input type="checkbox"/> _____ |

TITLE CHARIOTS TO ROCKETS

---

SUBJECT Social Studies, Art

LEVEL Intermediate

---

#### ACTIVITY IN BRIEF

The students will date the various modes of transportation concentrating on the evolution of the automobile.

---

#### OBJECTIVE

Each student will be able to date the major events in transportation

---

#### MATERIALS

handout I-7a  
roll of paper  
markers, pencils, etc.

#### TIME

Awareness - 15 minutes  
Concept - 2-3 class periods  
Application - 2 class periods

---

#### LEARNING CYCLE

**AWARENESS** - The students try to guess the dates of various automobiles I - 7a. They are shown pictures of other vintage cars.

**CONCEPT DEVELOPMENT** - The students research and develop a time line showing the evolution of the automobile starting with the various modes of transportation leading up to the invention of the automobile. The classroom artists will enjoy drawing the various vehicles.

**APPLICATION** - The students will design and write the specifications of a car of the future. The conservation of petroleum and/or other non-renewable energy sources should be considered.

**EVALUATION** - The student will be able to fill in dates and major transportation events of the past two centuries.

---

#### FOLLOW-UP/BACKGROUND INFORMATION

Students may be encouraged to bring in vintage car models that they have constructed from kits. A chronological arrangement for display may feature various aspects of vehicle and engine size and anticipated gas mileage of the various models. How do compact models of the 1980's compare with earlier models?

Transportation chronology (allow students to research and add additional transportation milestones).

- Early people - foot travel
- Stone age - dugout canoe
- Bronze age - the wheel (drawn by human or animal power - carts, chariots and other wheeled vehicles).
- 800 A.D. - Viking ship
- 1725 - Conestoga (covered) wagon
- 1800's - Clipper ships
- 1812 - Steamboat
- about 1850 - Stagecoach
- about 1850 - steam train
- 1903 - airplane (gasoline)
- 1903 - Horseless carriage
- 1937 - Turbo-jet engine
- 1954 - First nuclear powered ship (Nautilus)
- 1957 - First rocket propelled object in orbit (Sputnik)
- 1969 - Moon landing by astronauts
- 1972 - Interplanetary exploration pioneer I (first space craft to explore asteroid belt, fly by Jupiter, and leave solar system)

**SOURCE**

Janey Swartz and Duane Toomsen

In the United States more than half of the energy that comes from petroleum is used for transportation. Much of this is used by automobiles to move people from place to place. We are accustomed to using cars to maintain the way we choose to live. This is called part of our lifestyle. Below are drawings of automobiles. Can you determine by the design the decade (ten year period) in which these cars were made?

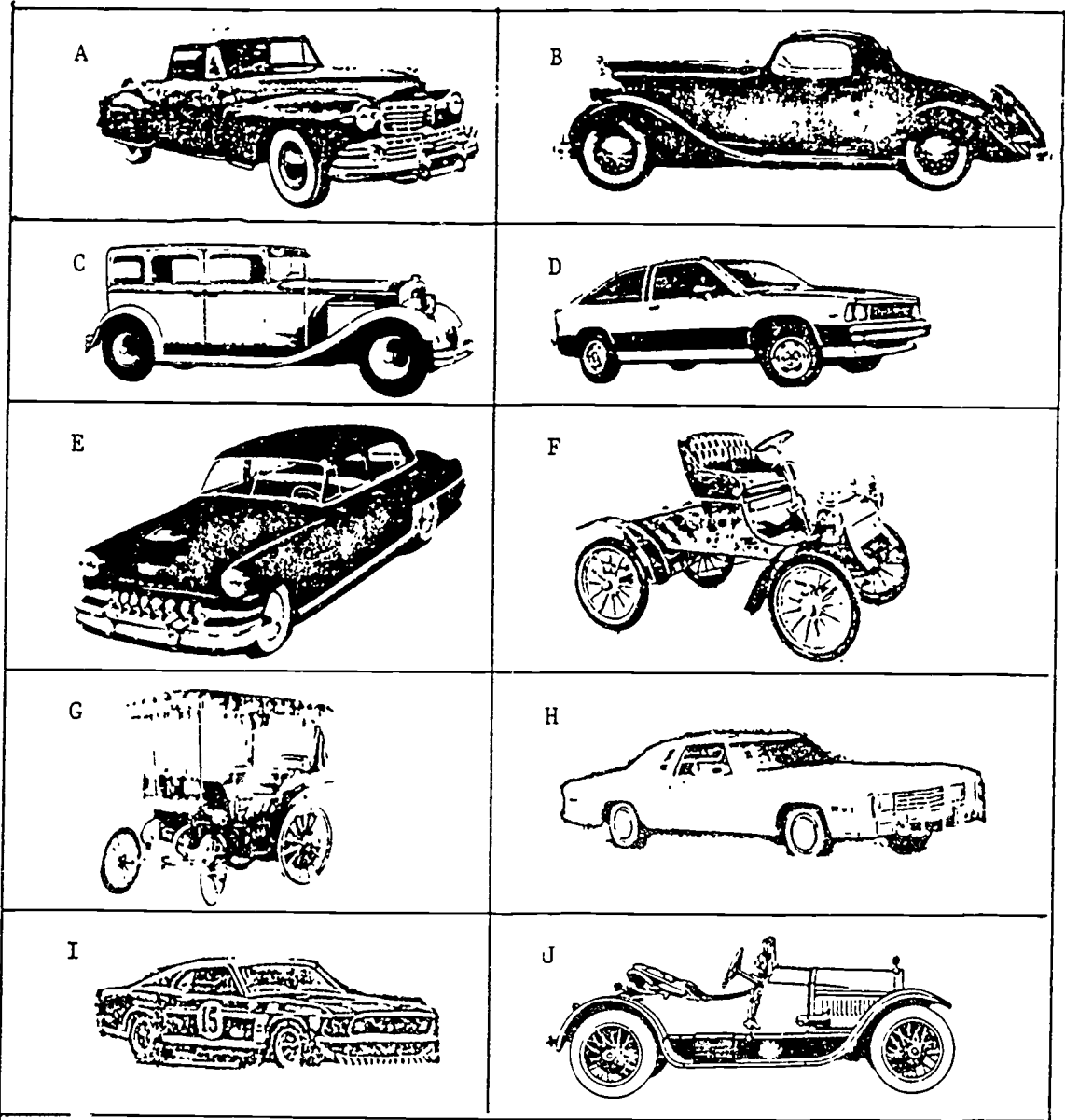

- |                 |                  |
|-----------------|------------------|
| 1. _____ 1890's | 6. _____ 1940's  |
| 2. _____ 1900's | 7. _____ 1950's  |
| 3. _____ 1910's | 8. _____ 1960's  |
| 4. _____ 1920's | 9. _____ 1970's  |
| 5. _____ 1930's | 10. _____ 1980's |

J. Buick "J" Roadster 1919  
 I. Ford Mustang 1965  
 H. Cadillac Eldorado 1978  
 G. Chrysler Hell Cat 1968  
 F. Model T Ford 1909  
 E. Buick Wildcat 1933  
 D. Chevrolet Cavalier 1981  
 C. Buick Wildcat 1933  
 B. Lincoln Continental 1948

TITLE YOU AUTO WALK

---

SUBJECT Mathematics, Art, Language Arts LEVEL Intermediate

---

#### ACTIVITY IN BRIEF

The students will evaluate some transportation habits and will think of ways to cut consumption of gasoline.

---

#### OBJECTIVE

The student will examine their personal transportation needs and evaluate strategies whereby they could reduce gasoline consumption.

---

#### MATERIALS

tagboard  
magazines  
handout 8a, 8b

#### TIME

Awareness - weeklong homework  
Concept development-15 minutes  
Application - 45 minutes

---

#### LEARNING CYCLE

**AWARENESS** - Each student will make a list of all the places he/she travels to by car in an average week. A family transportation journal is kept by each student. The odometer is read and recorded on the I-8a student sheet. The student will also interview five drivers asking questions concerning their driving habits (I-8b). They will make statements based on their interviews.

**CONCEPT DEVELOPMENT** - The student will brainstorm all the possible ways to reduce dependence on petroleum consumption for his/her transportation needs.

**APPLICATION** - The student will make an appeal for petroleum conservation by making a transportation collage and by making a statement concerning transportation practices (see Background Information).

**EVALUATION** - The student will state five ways the family could cut gasoline use and costs.

---

#### FOLLOW-UP/BACKGROUND INFORMATION

26% of all energy consumed in Iowa (and in the USA) is for transportation. Transportation accounts for 13% of all consumer spending. 300 million gallons of gasoline are used in U.S. automobiles every day.

Carpooling saves gasoline! If we raise the national average to two people riding in each car, the nation could save 5 billion gallons of gas each year.



Keeping cars in tuned and good running order could reduce an individual's gas consumption by 10%. Combining and planning trips saves gasoline. Riding a bike or walking whenever possible is healthy exercise and saves gas. Taking public transportation whenever possible and turning off the engine while waiting (such as at a fast food drive-up window) saves gas. Idling the engine wastes gasoline. Keeping tires properly inflated also conserves gas.

The students could write a story entitled, "How My Family Will Survive on 5 Gallons of Gas a Week."

The students need to be aware of the convenience aspect of owning and operating a car. We drive here and there often without thinking of the effect this luxury has on the world's petroleum reserves. There are many ways to cut down on gasoline consumption. Cutting down on "unnecessary" trips would be one way to do so. Carpooling whenever possible saves gasoline as well. If people could ask themselves, "Is this trip really necessary or is it simply a luxury?" and then arrange to drive only those trips deemed necessary, a good conservation ethic would be established.

The students could take part in a low fuel day. They would not use any (or limited amounts of) gasoline or fuel to get where they are going. Low energy transportation modes would be used, such as walking, biking, skating, etc. For every block walked, bicycled, etc., the student would receive a student designed "I-Saved-Gas-Buck". The one who collected the most could win a prize such as a pass to the skating rink, a bicycle decal, neon shoe laces, etc. or the fuel-saver winner could become Mr. or Ms. Energy gaining privileges and favors throughout the day.

Students need to be aware of the effect of automobile exhaust on the environment. Acid rain is a very serious and imposing problem due to the contributing effects of automobile exhaust. The students could color and discuss the picture dealing with acid rain. (See I-4e.)

#### SOURCE OF ACTIVITY

Janey Swartz

Name \_\_\_\_\_

# Transportation Journal of \_\_\_\_\_

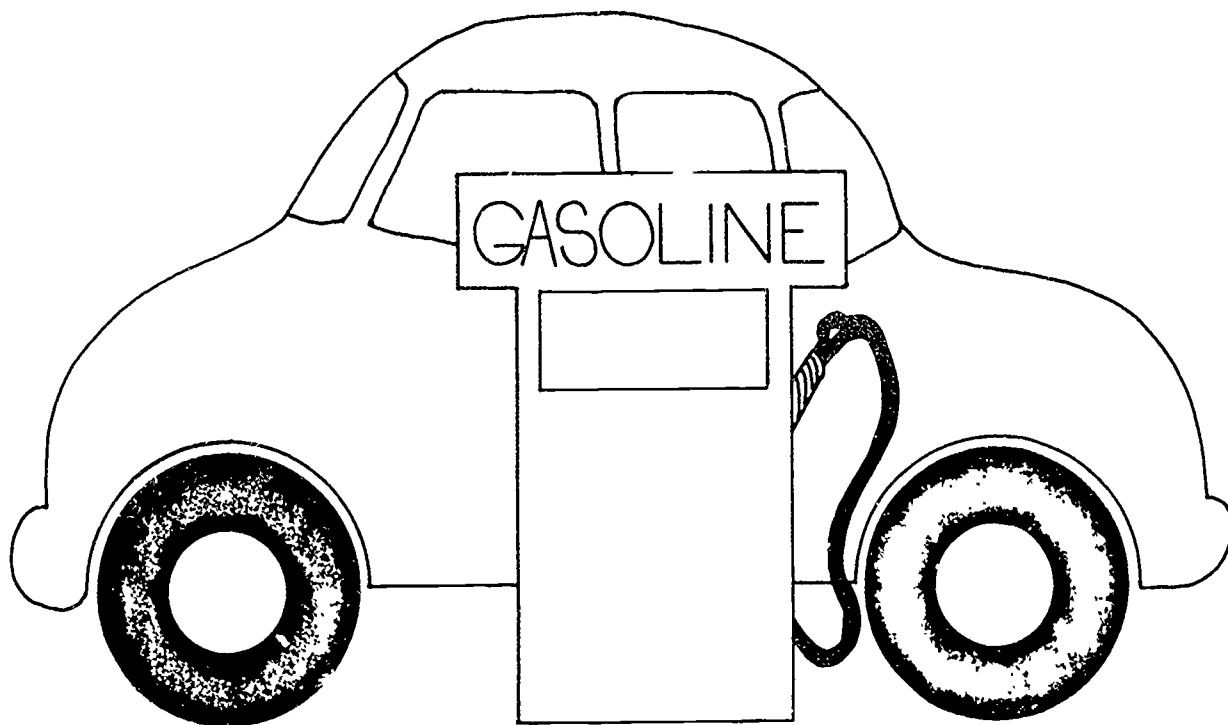

MON                  TUES                  WED                  THURS                  FRI                  SAT                  SUN

odometer reading							
miles traveled							
notes: places traveled to, etc.							

TOTAL MILES \_\_\_\_\_

My family car goes about \_\_\_\_\_ miles in a week.

It uses about \_\_\_\_\_ gallons in a week.

We spend about \$ \_\_\_\_\_ a week on gasoline.

I learned that \_\_\_\_\_

\_\_\_\_\_

TRANSPORTATION SURVEY INTERVIEW

by \_\_\_\_\_  
(name)

#1            #2            #3            #4            #5

1. How many years have you been driving?					
2. How many miles do you drive per day on an average?					
3. Could you get to any of your destinations by some other means of transportation?					
4. Do you car pool?					
5. If not, is car pooling a possibility for you?					

Can you draw any conclusions concerning driving habits and attitudes from the information obtained through your interviews? State your conclusions below.

---



---



---



---

**TITLE** CALCULATING CAR COSTS - WHEELING AND DEALING

**SUBJECT** Math, Art, Language Arts

**LEVEL** Intermediate

**ACTIVITY IN BRIEF**

Students will be given the opportunity to compare the costs of using a variety of forms of transportation.

**OBJECTIVE**

Students will be able to compute the costs of transportation and calculate a comparison of a variety of transportation forms and also of current automobile models.

**MATERIALS**

new car brochures

**TIME**

60 minutes

**LEARNING CYCLE**

**AWARENESS** - The students collect the following information: 1) current cost of lead-free (per gallon); 2) current cost of regular (per gallon); 3) current cost of diesel (per gallon); 4) family car's gasoline mileage; 5) calculate amount of money spent per week on gasoline.

**CONCEPT DEVELOPMENT** - The students will fill in the following chart which shows four types of vehicles, number of passengers per vehicle, and miles per gallon of fuel per vehicle. The gallons of gasoline used per mile by each vehicle and the miles per gallon per passenger could be computed by the student.

Vehicle	Passengers	Miles per gallon (mpg.)	Gallons used per mile	mpg per passenger
car	1.3	25	_____	_____
minibus (van)	8	20	_____	_____
bus	20	10	_____	_____
moped	1	100+	_____	_____

Ask:

- Which vehicle consumes the greatest amount of fuel? \_\_\_\_\_
- Which vehicle conserves the greatest amount of fuel? \_\_\_\_\_
- Which vehicle is the most energy efficient? \_\_\_\_\_
- Which vehicle is the least energy efficient? \_\_\_\_\_
- Why is the bus-which consumes the most fuel-not the least energy efficient? \_\_\_\_\_

APPLICATION - The students will collect information about gas mileage and price listings of various automobiles. A visit to a car dealership for brochures and other information would be helpful. Then the students will put together a "Transportation Guide" of the 80's. Each page will feature and advertise a current model automobile. All the ads will be compiled into one book. Throughout the year, more drawings, pictures and information about transportation can be included.

Students should be asked to select five brands or styles of automobiles ranging from sub-compact to full size luxury cars. They should respond to the following questions:

1. What is the vehicle's gas mileage rating?
2. What is the estimated price of the vehicle?
3. How many people will the vehicle usually need to carry?
4. What are the selling features of each model?
5. Which model and brand would each student select?
6. What criteria did they consider in making their selection?
7. Will you consider another form of transportation instead of an automobile?

EVALUATION - The student will state the gas mileage of the family vehicle and will compare it with the efficiency of three other forms of transportation. The student will list five important items of consideration for their present and future transportation.

---

#### FOLLOW-UP/BACKGROUND INFORMATION

See I-8 Background Information

#### SOURCE

Adapted from Watt's Happening.

**TITLE** Operation Pipeline!

**SUBJECT** Science, Art, Creative Dramatics **LEVEL** Intermediate

**ACTIVITY IN BRIEF**

Students will act out the sequence of events dealing with natural gas (from drilling site to the home.)

**OBJECTIVE**

Each student will describe the sequence of events from natural gas production to the delivery to the power plant and to the home. The student will be able to explain where and how their community gets its natural gas.

**MATERIALS**

handouts 10a  
10b (optional)

**TIME**

Awareness - 30 minutes  
Concept development - 15 to 30 minutes  
Application - One session - variable

**LEARNING CYCLE**

**AWARENESS** - The students "become" the various components of the natural gas distributing system. Two children form the drilling rig, four or five more join hands to become the pipe line, carrying natural gas to the power plant. Four children become the trees in the forest which need to be chopped down so the pipeline can go through. The three children forming the power plant make electricity using the natural gas as fuel. Four more children become electric lines "zapping" electrical current to the house (2 or more children). One child becomes the radio in the house, another becomes the pot of water. Two students move about to show energy loss due to heat and friction. The teacher directs the floor plan. The students pose as the various components. They also create the sound effects. The teacher will establish the order of events from drill site to the teakettle. When the pot of water boils and the radio broadcasts a weather report, the chain of events has been completed.

- |                   |              |                                                                                          |
|-------------------|--------------|------------------------------------------------------------------------------------------|
| 1. Drilling rig   | 2 students   | hold hands and pump up and down - making pumping sucking sounds                          |
| 2. Pipe line      | 4-5 students | connect hands - "swish swish" sound                                                      |
| 3. Trees          | 4 students   | outstretch and connect arms (fall when "chopped down" for the pipelines to come through) |
| 4. Power plant    | 3-5 students | make electricity (turbines could spin around)                                            |
| 5. Electric wires | 4 students   | connect hands and "zap-zap" electrical current                                           |

- |                 |            |                                                                         |
|-----------------|------------|-------------------------------------------------------------------------|
| 6. Pot of water | 1 student  | boils and makes "bubble-bubble" sounds when the electricity reaches it. |
| 7. Radio        | 1 student  | broadcasts a weather report when the electricity arrives                |
| 8. Friction     | 2 students | dance about the system to show heat loss because of friction            |

**CONCEPT DEVELOPMENT** - The students color and verbalize the chain of events from drilling rig to radio. Notice there is a direct pipeline to the house for the gas stove and furnace. (The teacher should point out the fact that some stoves and furnaces use natural gas.) (See I-10a)

**APPLICATION** - A resource person from the utility company is invited to talk about the community's source of natural gas, location of pipe lines, construction of pipelines, pipeline safety, etc. Maps would be helpful to show natural gas sources and pipelines.

**EVALUATION** - Students will be able to trace the process of obtaining natural gas from the well and bringing it into the home. Students will be able to list five uses of natural gas.

---

#### **FOLLOW-UP/BACKGROUND INFORMATION**

##### How Natural Gas is Formed

A very, very long time ago before people lived on earth, it was covered with many tiny plants and animals. Some lived on land, some in water. As the animals died on the land, they were covered with leaves falling from the trees, and dirt blowing in the wind, and rain falling. Sometimes they were washed into the water. As the animals in the water died, they were covered by sand and mud and underwater plants that died, too. After a long time the plants and animals and dirt all mixed together. This new material was called organic matter. The sand and dirt and mud that covered the organic matter turned into rock. Many layers of organic matter and rock were formed in this way. Later, heat and the weight from rocks above changed the organic matter into tiny bubbles of natural gas. This natural "gas" stayed under the heavy rock. Sometimes when there was a small crack in the rock, the natural gas would go up through the crack to the top of all the layers of rock and soil and mix with the air on the surface of the earth. When mixed with air and heat, natural gas can burn. Sometimes people saw natural gas burning on the surface of the earth or on top of the water. Most of the time there were no cracks in the rock and the natural gas stayed trapped deep underground. There are still many layers of natural gas under the ground today.

##### How Workers Explore for Natural Gas

Many years ago people saw a flame on the surface of the earth. They wanted to find out how and why this was happening, so they began to dig. They dug a deep hole near the flame to help more gas come to the surface. By doing this, the flame got larger. When the people put a cover over the hole the fire flame went out. They learned that whatever was burning was coming from the hole ... even though they could not see, touch, smell or hear it. They put hollow logs together in a long line to make the natural gas go where they wanted to use it. When the gas came out at the end of the logs, they lit it and used the flame for light and heat for their streets and homes.

There are many places in the United States where natural gas may be found under the earth. People try to find these places and help the natural gas get to the surface of the earth. These people are called "geologists." One of the ways geologists discover natural gas is to look at rocks and soil on the surface of the earth. There are many kinds of rocks. When the geologist finds a certain kind of rock and soil that is usually found near natural gas, he/she will dig a hole to see if the gas is there.

#### How Workers Drill for Natural Gas

The geologist uses a very big machine that can dig very deep into the ground. This machine is called a drill. Sometimes the workers drill deep into the ground and find gas and sometimes they do not discover gas. Other times, they will find small amounts or large amounts. For example, if six drills look for natural gas, usually only one will find a large amount. Also, the deeper the drill can dig, the more natural gas it can find. Bigger and stronger drills are being made so workers can dig deeper holes.

#### How Natural Gas is Transported for Use In Homes, Schools, Businesses and Industry

After the drills dig the holes and bring the natural gas to the earth's surface, the natural gas is cleaned. Natural gas is sometimes made up of many gases and is found near oil. The gases and oil are then separated and put into different holding tanks. After the natural gas is cleaned, it is taken to where it is burned by people to heat their homes, schools, businesses and factories. There are many ways to do this. One way is to help the natural gas into long pipes - just like the hollow logs that were used a long time ago. Today, these pipes are made of metal and plastic. There are many pipes carrying natural gas all over our country. Natural gas is transported in thousands of miles of pipelines put underground. If all the pipes were stretched out in a straight line, they would go as far as to the moon and back to the earth more than two times!

The nearest town using the natural gas is called the "city gate". It is here that the gas is measured and sent in the underground pipeline to homes and other buildings.

The equipment at the city gate does many jobs:

1. The gas is measured.
2. More smell is added to the gas so that if any leaks out, it can be found.
3. The gas is put into smaller pipes.
4. Extra gas that was saved in the summertime can be added.

After passing through the city gate, the gas enters the pipes that take it closer to the homes and other buildings in the community. These pipes are called gas "mains." There are "valves" with handles along the way, so that in case of fire or flood in the city, the natural gas can be stopped in the pipes until it is safe to turn on again.



When the natural gas arrives through the natural gas main, it enters an even smaller pipe to travel into each building. Each building also has a valve so that the supply of gas may be turned off and on without stopping the supply to neighbors. When the natural gas enters a building, it goes through a meter to be measured. A "meter reader" comes to the building every month to read the numbers on the meter. These numbers tell how much natural gas each building has used and must be paid for.

### Using and Storing a Supply of Natural Gas

Many buildings use natural gas to heat themselves, to heat water and make things to sell in the community. It takes energy from gas to make cereal, bake bread and cook food before it is put into cans. It takes energy from gas to make steel. Natural gas is used to make fertilizer so the farmer can grow bigger corn and tomatoes. It is also used to make "synthetic fibers" for some of the clothing we wear. Perhaps natural gas heats your school. Natural gas can provide energy to do many other jobs. It melts glass and generates heat for pasteurizing milk. The barber shop, the grocery store, the beauty shop, the office buildings may all use natural gas to help make your community a more comfortable place to live.

Natural gas is used for energy in many communities. More and more natural gas is needed as communities grow larger and when new ways are found to use it.

In the wintertime, when it's cold, more natural gas is needed to heat homes and buildings. During the summertime when we do not use very much natural gas, the company that pipes the gas to your house, stores it in underground storage tanks. In the wintertime, when more natural gas is needed, this stored natural gas can be quickly added to the natural gas in the pipelines. When natural gas is stored, it is changed into a liquid by making it very cold. When natural gas is changed to liquid, it gets smaller. Then large amounts of natural gas, called liquefied natural gas, LNG, can be saved in big tanks near the communities where it will be used.

Background Information was prepared by Donna Bernard, Energy and Mans Environment. See I-10b for more natural gas products.

### **SOURCE OF ACTIVITY**

Janey Swartz

# NATURAL GAS

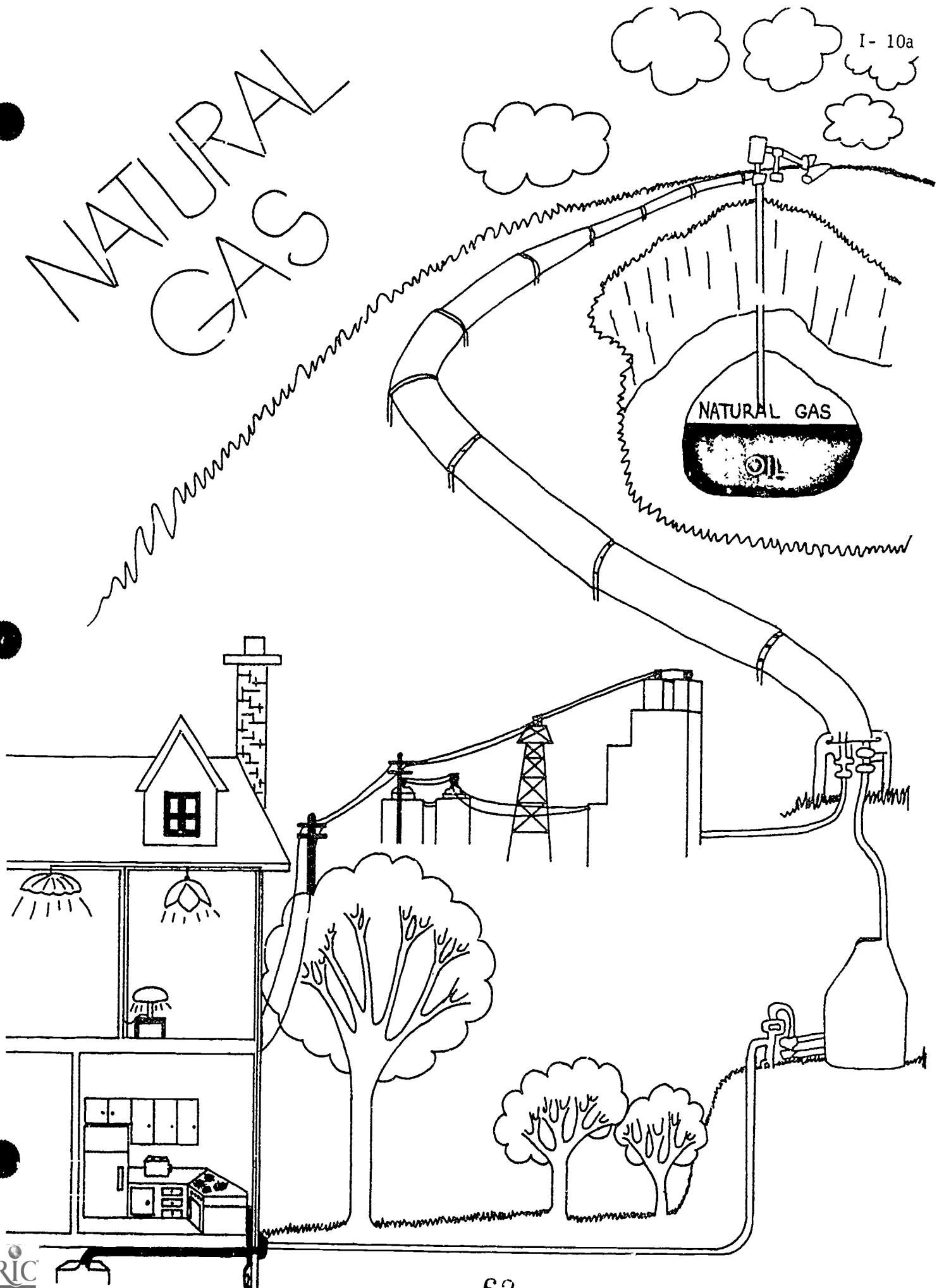

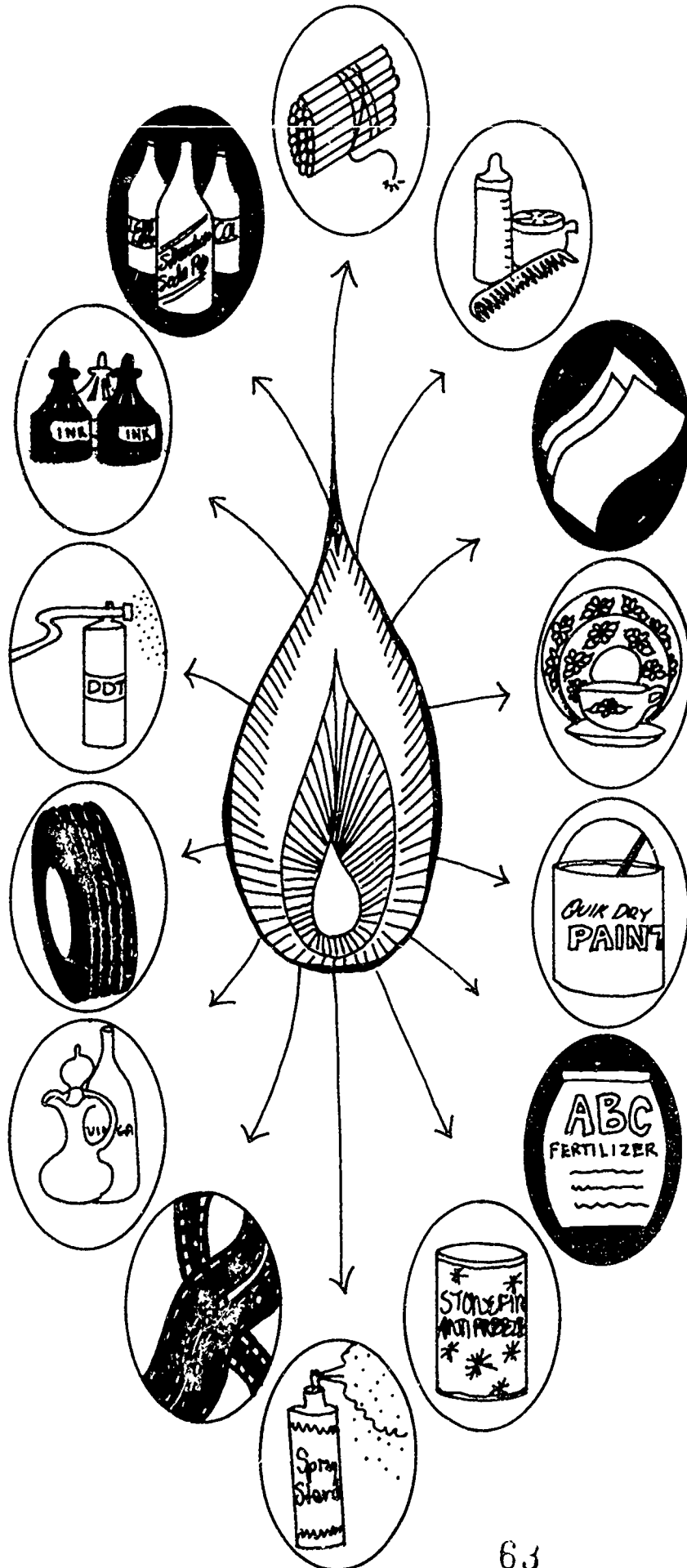

**TITLE** Turn That Turbine

---

**SUBJECT** Language Arts, Science

**LEVEL** Intermediate

---

**ACTIVITY IN BRIEF**

Students observe how electricity is produced using an electric meter and a magnet, and coil. They assemble the pieces of an electricity-generating plant.

---

**OBJECTIVE**

Students will be able to construct an electromagnet and demonstrate energy sources used to turn turbines that can generate electricity.

---

**MATERIALS**

see I-11a  
pinwheel(s)  
water container  
tubing for siphon as needed for turbine  
handouts I-11a, 11b, 11c, 11d, 11e, 11f

**TIME**

2 - 3 45 minute class periods

---

**LEARNING CYCLE**

**AWARENESS** - Students will experiment with a magnet and a wire coil to see how electricity is produced. (See I-11a). They will try many ways to increase the amount of current as shown by the electric meter.

**CONCEPT DEVELOPMENT** - The teacher will emphasize the difference between the weak electric current they have generated in class and the powerful current that comes to their homes from electric generating plants. The teacher will introduce the idea of the turbine by demonstrating with a pinwheel. Ask: How could this "turbine" be used to turn a magnet in a coil so as to produce an electric current? Discuss the three major ways to turn a turbine: steam, wind and flowing water. The students will draw in the missing electricity generating plant parts (see I-11b, c, d, e). The pages could be cut in half (on dotted line) to make a booklet.

**APPLICATION** - Visit or send for information from the area electricity generating plant. What source of energy is used? What is most of the electricity in the area used for? The students will complete I-11f.

**EVALUATION** - The student will demonstrate how electricity is generated by words or pictures choosing any one energy source.

---

## FOLLOW-UP/BACKGROUND INFORMATION

Most electricity is commercially produced using large generators. The generator consists of two parts: the armature, which is a large coil of wire, and magnets, which are usually electromagnets. By moving the coil of wire through a field of the magnets, a current, (a flow of electrons) is induced (produced) in the wire.

It does not matter whether the coil of wire moves through the magnetic field or whether the magnetic field moves over the wire. The current is always produced in the wire.

So, something has to turn the coil or the magnet. Without energy to do that turning, no electricity can be produced. In an electric generating plant, that energy usually comes from a large windmill-type apparatus called a turbine. The turbine has many blades attached to a shaft.

The turbine is usually spun by hot, expanding steam from a boiler and the steam is produced by burning fossil fuels or using a nuclear reaction to heat water. Running water [hydropower] can also be used to spin a turbine. So can wind.

When the turbine turns, its shaft turns. The shaft is attached either to the armature (coils) or to the magnet, and it turns it, generating electricity. The electrical current that is produced is a flow of electrons, in the wire, which can be utilized in various ways. If the end and the beginning of the wire are connected through a radio, for example, the radio will play!

A pinwheel may be used for a wind turbine. A container of water, a siphon hose and a paddle wheel can be made to simulate a turbine.

## SOURCE

Janey Swartz. I-11a from: Energy and Safety: New York Energy Education Project.

## HOW CAN YOU MAKE ELECTRICITY WITH A MAGNET?

Of course you know how a magnet can pick up small metal objects. You can actually make a tack jump to the magnet by holding them close together.

Magnetism is a form of energy. It can push or pull things. It can even push or pull some of the tiny particles that make up matter: electrons. And when you push or pull electrons, you get electricity.

Let's try making electricity with a magnet.

### MATERIALS

100 cm of bare copper wire  
 1 bar magnet  
 1 electric meter  
 1 cardboard tube

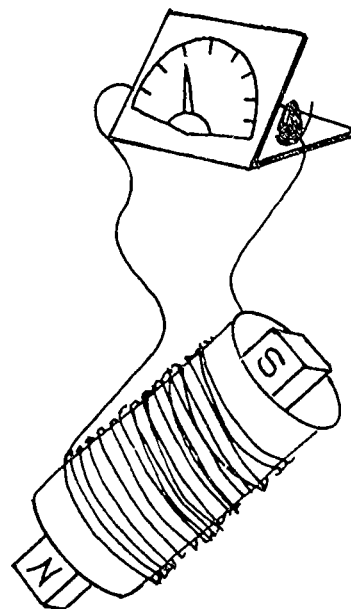

### STEPS

1. Wind the wire around the tube about 20 times.
2. Connect both ends of the wire to the meter, as shown by your teacher.
3. Take the magnet and move it near the coil but not through it. Observe the meter.
4. Move the magnet in various directions around the coil.
5. Move the magnet through the coil, back and forth. Make more than one trial doing this. Try moving the magnet at different speeds. Move the coil over the magnet, keeping the magnet still.

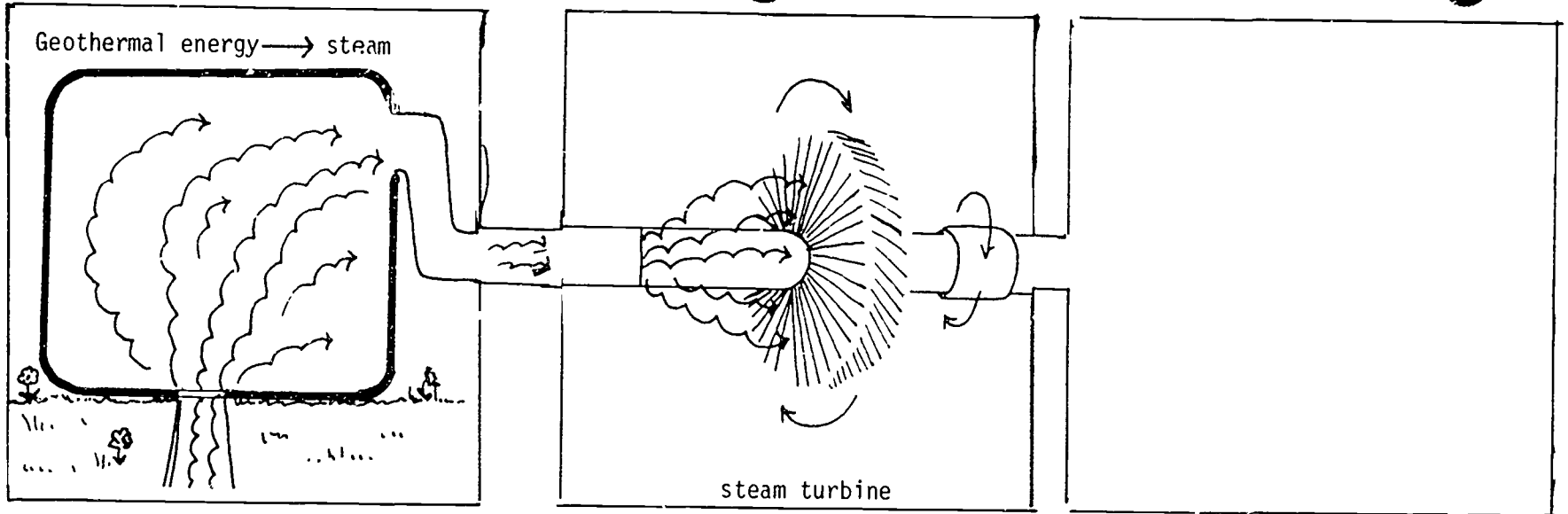

We get steam from beneath the earth's surface to produce a small amount of electricity.

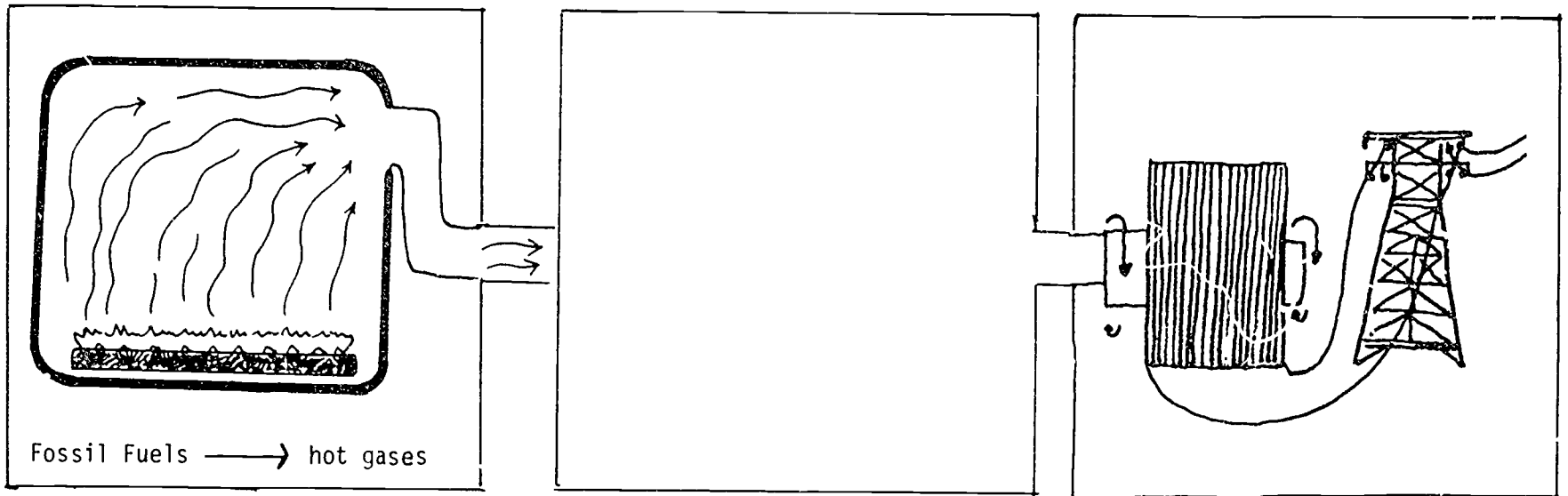

We burn coal, oil, or natural gas to make hot gases to produce electricity.

I-11b

67

68

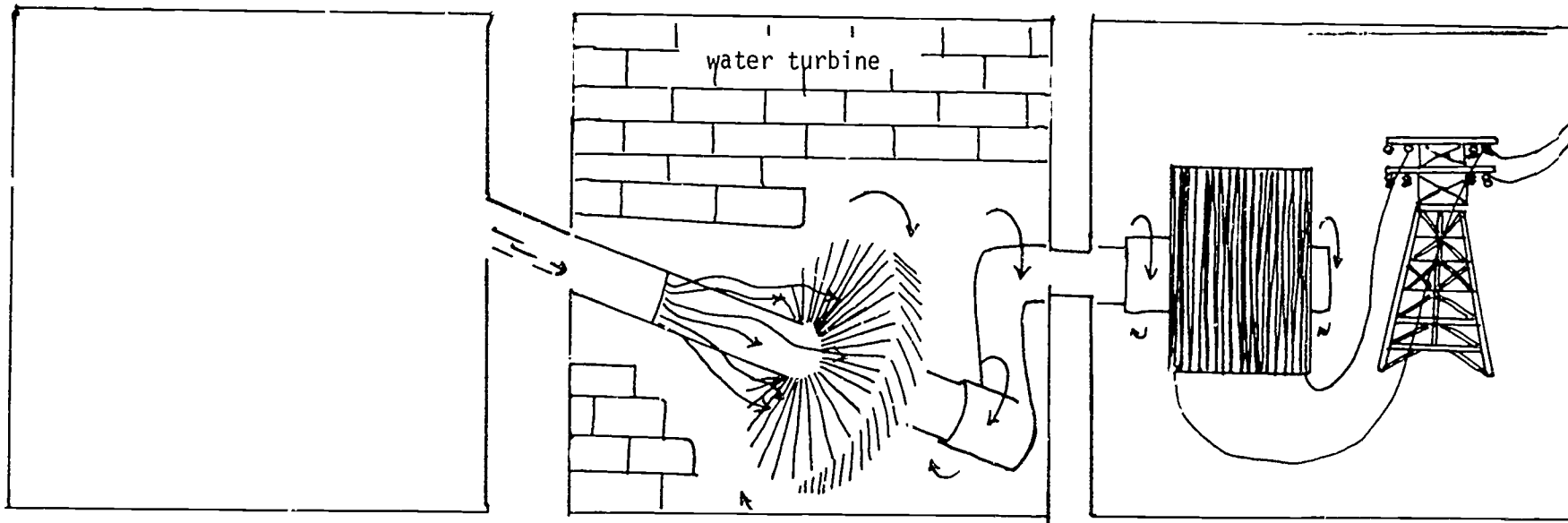

We dam up water to turn turbines to make 13% of our electricity.

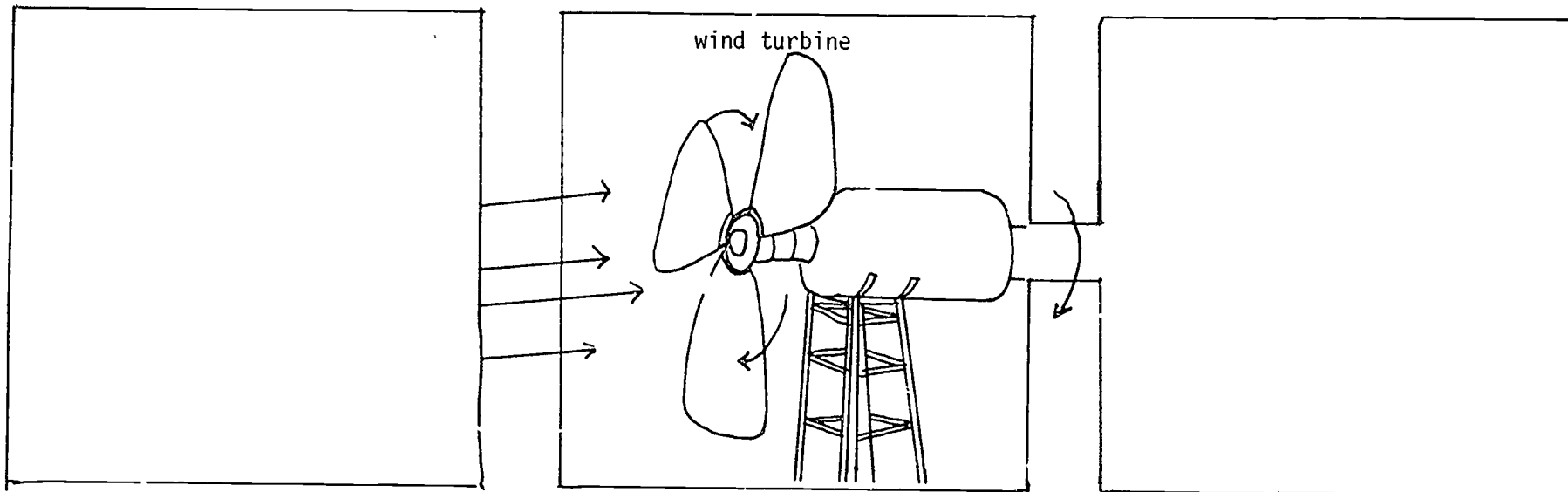

We use the wind to turn turbines to produce a very small amount of electricity.



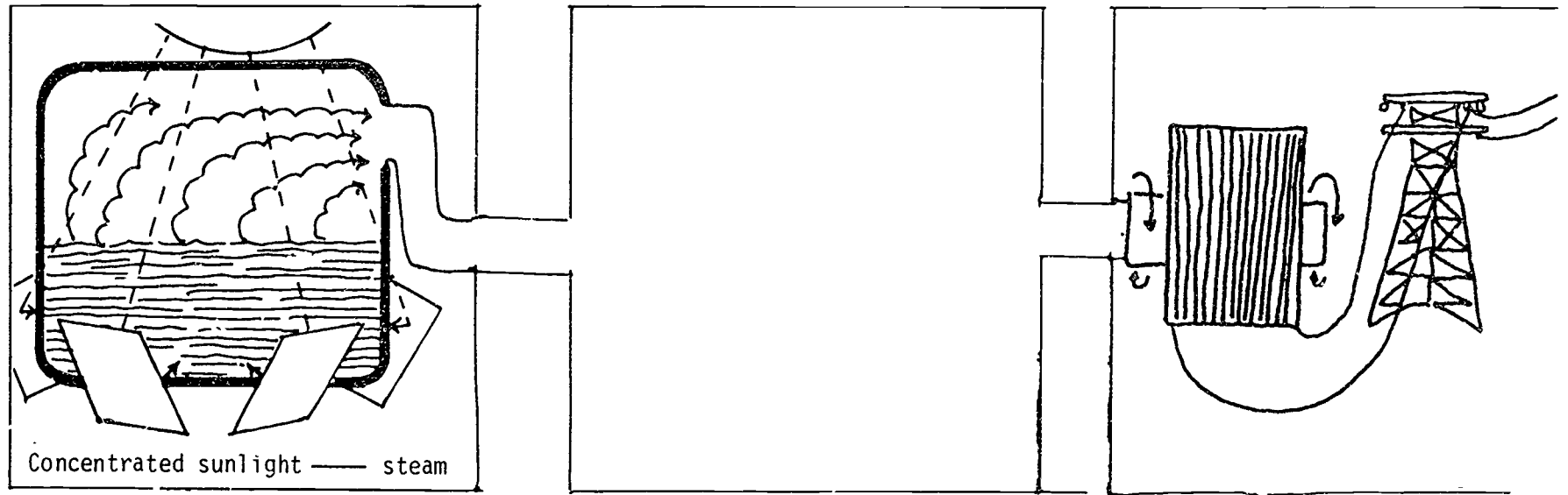
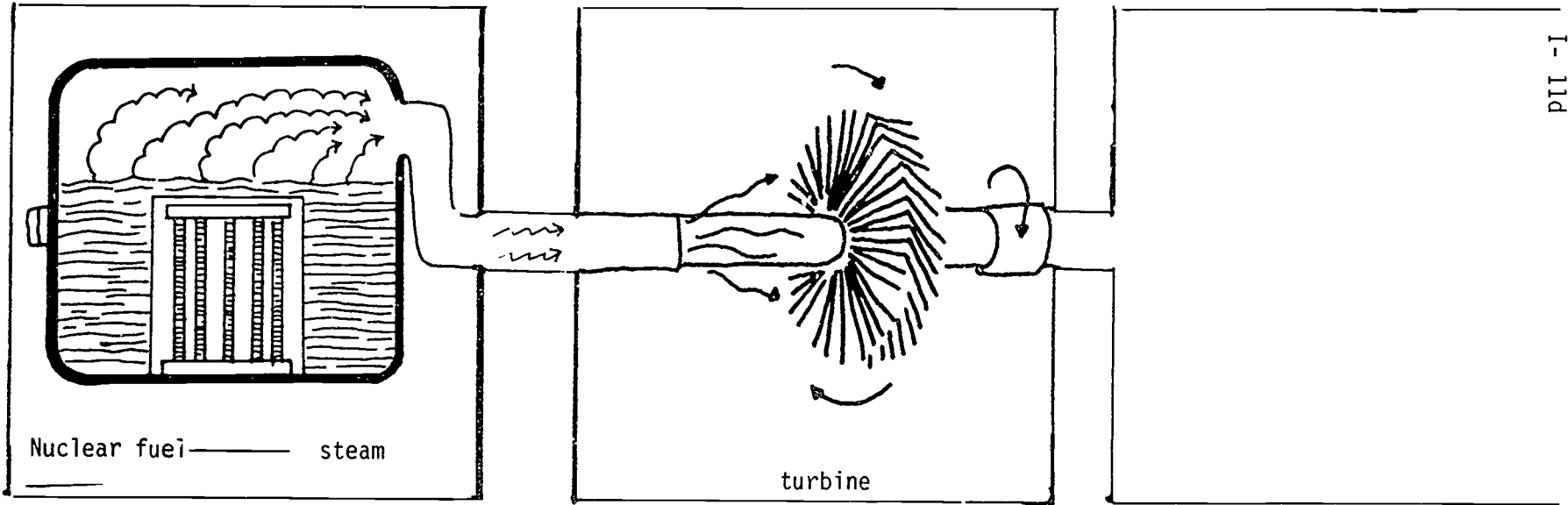

We can concentrate sunlight to make steam, but this is still experimental.

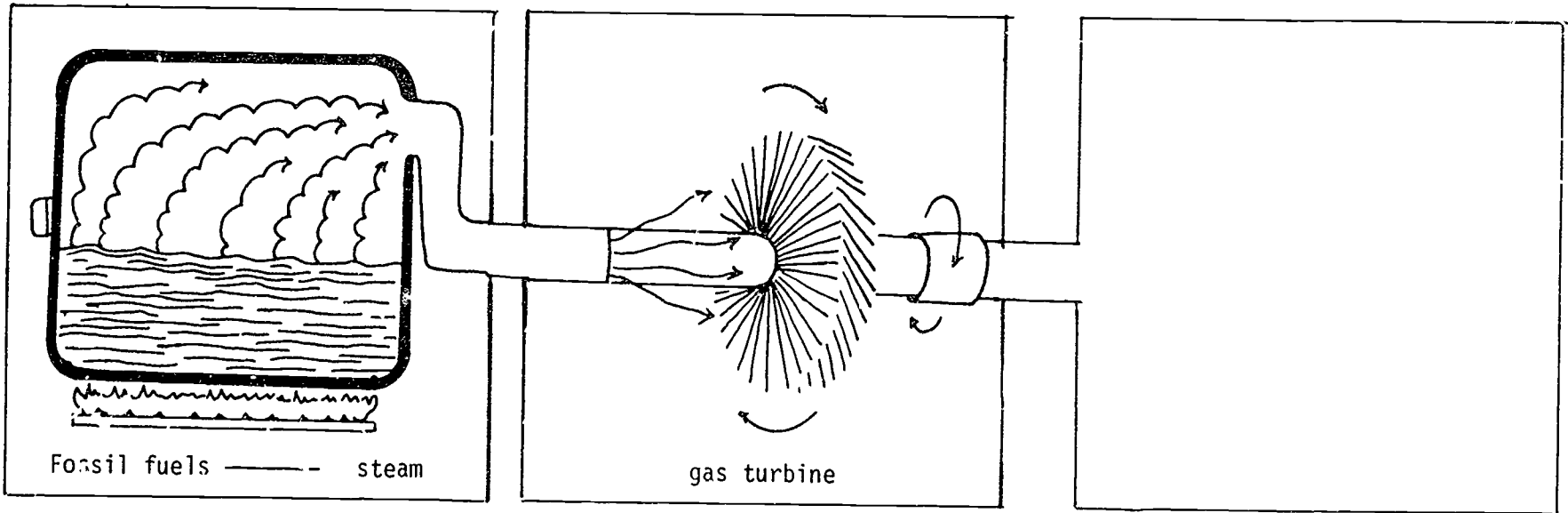
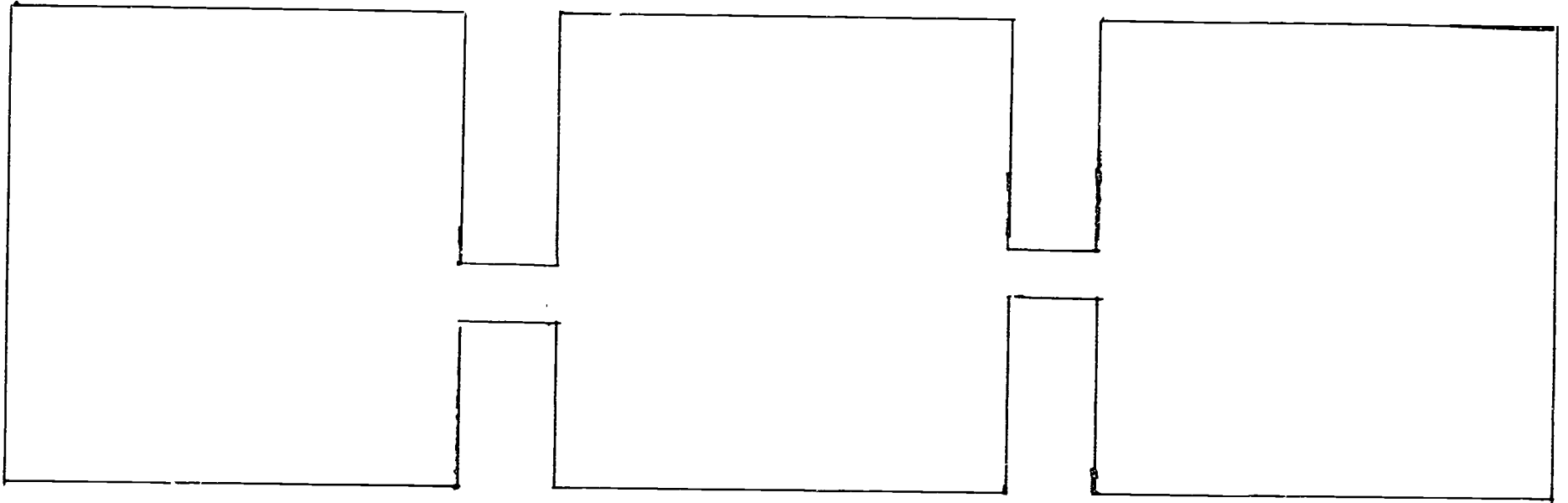

We burn coal, oil, or natural gas to make steam to produce 72% of our electricity.

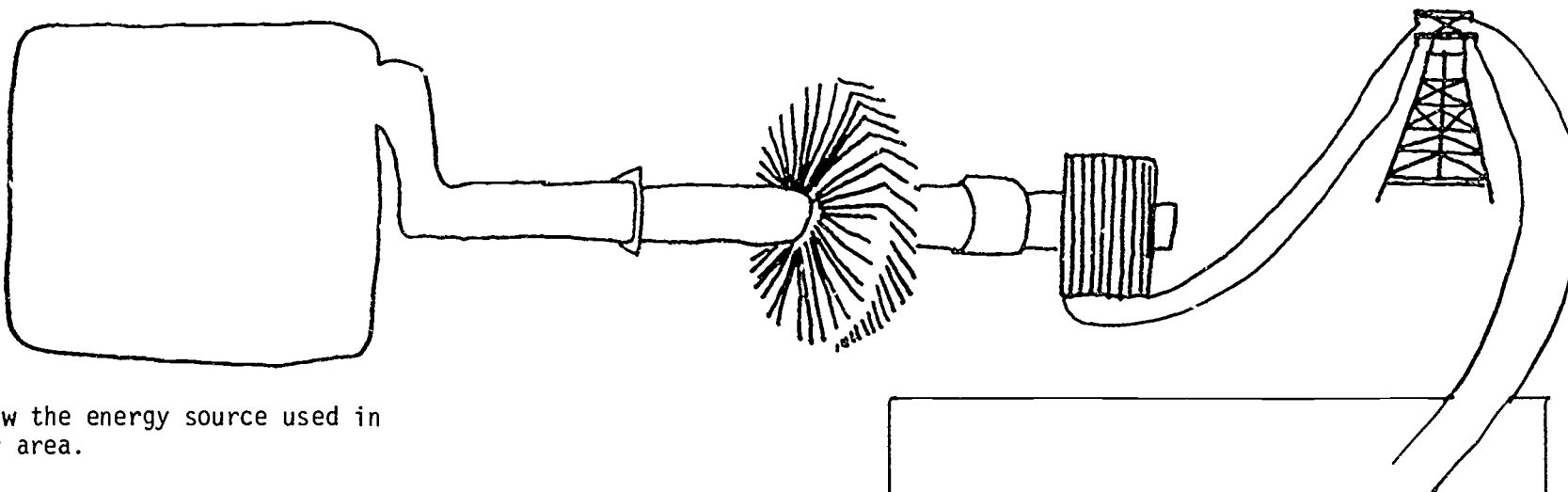

I- 11f

Draw the energy source used in our area.

- |                                      |                                  |
|--------------------------------------|----------------------------------|
| <input type="checkbox"/> nuclear     | A. most used in our area         |
| <input type="checkbox"/> fossil fuel | B. most expensive                |
| <input type="checkbox"/> wind        | C. most efficient                |
| <input type="checkbox"/> hydro       | D. most dangerous                |
| <input type="checkbox"/> geothermal  | E. most accessible               |
| <input type="checkbox"/> solar       | F. greatest polluter             |
|                                      | G. most promising for the future |

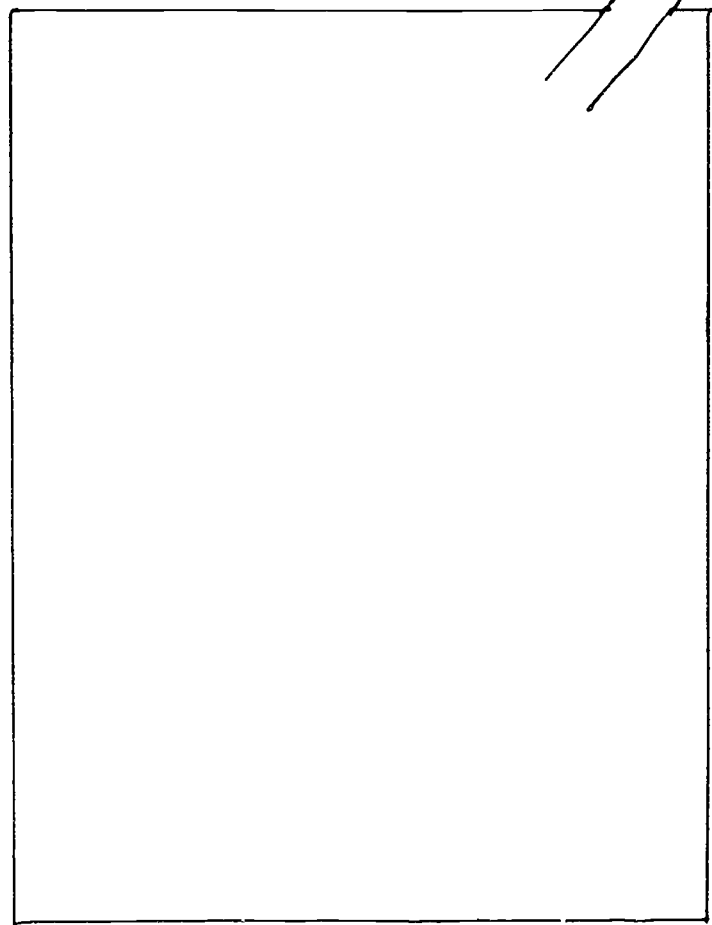

Draw what most of the electricity in our area is used for.

**TITLE** What Is My Electrical Future?

---

**SUBJECT** Language Arts, Science, Writing      **LEVEL** Intermediate

---

**ACTIVITY IN BRIEF**

Students will research energy sources other than fossil fuels, that may provide current and future power for electrical energy generation.

---

**OBJECTIVE**

Students will be able to state advantages and disadvantages of energy sources that are not dependent upon fossil fuels.

---

**MATERIALS**

pencil and handout I-12a  
research articles and background information

**TIME**

Awareness - 10 minutes  
Concept development - 45 min.  
Application - 20 minutes

---

**LEARNING CYCLES**

**AWARENESS** - The students make a list on the board of all the possible forms of energy which could be utilized to turn the turbine and to generate electricity.

**CONCEPT DEVELOPMENT** - The students divide into small groups. Each group is assigned an energy source (solar, wind, biomass, nuclear fission, hydro power (water) or geothermal. Research information is gathered and shared with the class and information is collected on the chart I-12a.

**APPLICATION** - The students will consider the challenge of the future: to become less dependent on sources of energy that are in danger of running out, to develop and use energy sources whose availability is renewable and whose use will not disrupt or pollute the environment. Each student will write a letter to the Department of Energy appealing for increased research and/or a commitment to their most promising energy source.

---

**FOLLOW-UP/BACKGROUND INFORMATION**

Letters can be sent to the Department of Natural Resources, Energy Division, Wallace State Office Building, Des Moines, Iowa 50319.

Solar energy is clean and renewable! It is one of our most promising future energy sources, but it now supplies only about 1% of the energy used in the U.S. and in Iowa.

Wind, too, provides only about 1% of the energy used in the U.S. and in Iowa. Some scientists predict that by the year 2000, 10% of our energy needs could be supplied by wind, but the equipment needed will be costly. Wind is unpredictable so ways to store the energy need to be developed. Any wind over 8 m.p.h. can be used to generate electricity.

Ocean tides are among the most powerful forces on the earth. To harness the rising and falling of the tides would be an expensive process, but this could be a very important future energy source for the Eastern United States. Perhaps underwater windmills or floating generating stations could utilize this potential energy source to produce electricity.

Nuclear fission, the splitting of the atom, releases tremendous amounts of heat. The heat released can in turn produce electricity. (Heat boils water, which produces steam, which drives a turbine, which runs a generator, which produces electricity.) Fission provides 3.5% of the energy in the U.S. and 6.4% of the energy used in Iowa. Major problems exist however; safety concerns for disposing the radioactive waste products, the possibility of a meltdown, releasing dangerous radiation into the environment, the danger of theft of nuclear fuels, and dangers of radiation exposure to the workers in a nuclear power plant.

Energy can be obtained from "garbage," or biomass. As bacteria decomposes, organic wastes (such as manure, septic tank sludge, food scraps, pond-bottom muck, etc.) methane is produced. Methane is the same as natural gas from the ground. There are power plants in the U.S. which use methane derived from organic wastes (mainly manure). Some cities produce electricity by burning garbage in specially designed power plants.

Nuclear fusion, is considered by some to be the alternative energy resource with the greatest potential for the future. Fusion is produced by combining the centers of two atoms. Fusion releases far greater energy than splitting the atom. Although fusion is a nuclear process, it has many advantages compared to nuclear fission. 1) meltdowns could not occur, 2) large quantities of radioactive shipments would not occur since hydrogen is the basic ingredient necessary, 3) the amount of radioactive waste would be much less, 4) danger of theft of nuclear fuels would not exist and 5) seawater, a nearly inexhaustible resource can be used. Scientists need to solve one major problem before we can use fusion for energy . . . how to create the extremely high temperatures necessary to fuse the atoms. (The temperature of the sun, where nuclear fusion occurs, is about 15 million degrees Centigrade at its center.)

Geothermal energy refers to the energy from the heat deep within the earth. The water and steam which gushes from a geyser could be used to turn a turbine, thus producing electricity.

Falling water (hydroelectric energy) provides 4% of the energy used in the U.S. and 2% of Iowa's energy. When water falls over dams, giant turbines spin and produce electricity. Hydroelectric power plants do not cause pollution, but problems do exist. There are fewer and fewer places left to build dams. When a dam is built on a river, environment issues occur, because lakes are created where land once stood.

Ceramics. Scientists are working hard at developing ceramics that reduce electrical energy loss by heat resistance (friction). It is conceivable that in the near future the electrical powered automobile and an entire array of new appliances will become available that will use far less electrical energy. Current science magazine articles will supply some information concerning ceramics and new breakthroughs in electrical energy transmission. The villain of friction will not be totally conquered, but may be subdued at immense energy savings.

#### SOURCE OF ACTIVITY

Adapted by Janey Swartz

ENERGY  
SOURCE

ADVANTAGES

DISADVANTAGES

SOLAR		
WATER		
WIND		
BIOMASS		
NUCLEAR FISSION		
GEOTHERMAL		
OCEAN TIDES FALLING WATER		

80

**TITLE** Electrical Lifestyle

**SUBJECT** Social Studies

**LEVEL** Intermediate

---

**ACTIVITY IN BRIEF**

Students list their family's electrical appliances and prioritize them as to their importance and then they decide if the item is a luxury or a necessity. They think about their own lifestyles and consider some energy conserving actions they could take.

---

**OBJECTIVE**

Each student will name electrical necessities and luxuries in his/her daily living. The student will compare their luxuries and necessities with other students.

---

**MATERIALS**

handouts I-13a, I-13b, I-13c, I-13d

**TIME**

Awareness - 30-45 minutes  
 Concept Development - 45 minutes

---

**LEARNING CYCLE**

**AWARENESS** - The students review the items they own and use in their homes. (See I-13a). Then they write the names of electrical appliances they consider most important to them on the electrical outlets. (See I-13b) The families help may need to be solicited. An "N" for necessity and an "L" for luxury is lettered under each item.

**CONCEPT DEVELOPMENT** - The teacher calls on one student to name off the items on his/her list. If anyone else has any new items, those are added and so on until every student has his/her items appearing on the one class list. Each student is given a blank chart. (See I-13c) Each item is voted either a luxury or a necessity by a show of hands. The student then organizes a way to show the class's top 10 luxuries and top 10 necessities. (Charts, pictures, diagrams, etc.) The teacher may want to group the students for this project instead of having the students work individually.

**APPLICATION** - The student considers eliminating 3 luxury items and 2 necessities in order to conserve energy. A "fast" for a week is experienced and at the end of the week the student expresses his feelings about the new "lifestyle" experienced. The items which are eliminated for a week could be brought to school and placed on a table to symbolize the sacrifices being made by the students. What alternatives or substitutions were made? Would he/she be able to comfortably continue without these items?

**EVALUATION** - Each student will name five luxuries and five necessities dependent on electricity.

---



**FOLLOW-UP/BACKGROUND INFORMATION**

The students hold an all school, no (or low) electricity day. Little or no electricity should be used. (Lights, duplicated materials, audiovisual equipment, balls, food preparation, etc., would all be affected. A sort of a return to "Little House on the Prairie" days would be enacted.) Students may want to go a step farther and see how they can function without using electricity at home as well. (Toaster, oven, hair stylers, radio, T.V., lights, hot water, etc., would all have to be sacrificed.) Obviously, the cooperation and support of the school administration and the family would be a necessity.

**SOURCE**

Modern living would be difficult without electrical energy. Many of the conveniences we enjoy today would be impossible without electricity. Of the total energy used in homes, 70% is used for heating and cooling, 20% is used for heating water and 10% is for lights, cooking and small appliances. Illustration "Can You Guess?" compares the energy consumption of some common household items. (See I-13d.)

**SOURCE OF ACTIVITY**

Energy Conservation Activity Packet (ECAPS) "Can You Guess?" activity by Sheree Pandill.

# My Electrical Lifestyle

Name \_\_\_\_\_

Check each item you have in your home. Double check items you use yourself.

- |                                           |                                              |                                              |
|-------------------------------------------|----------------------------------------------|----------------------------------------------|
| <input type="checkbox"/> air conditioner  | <input type="checkbox"/> hair curler         | <input type="checkbox"/> orange squeezer     |
| <input type="checkbox"/> food blender     | <input type="checkbox"/> clothes dryer       | <input type="checkbox"/> pencil sharpener    |
| <input type="checkbox"/> dehumidifier     | <input type="checkbox"/> electric fan        | <input type="checkbox"/> electric stove      |
| <input type="checkbox"/> humidifier       | <input type="checkbox"/> space heater        | <input type="checkbox"/> waffle iron         |
| <input type="checkbox"/> dishwasher       | <input type="checkbox"/> lamps               | <input type="checkbox"/> toaster             |
| <input type="checkbox"/> door bell        | <input type="checkbox"/> sandwich grill      | <input type="checkbox"/> musical instrument  |
| <input type="checkbox"/> back massager    | <input type="checkbox"/> electric knife      | <input type="checkbox"/> griddle             |
| <input type="checkbox"/> electric blanket | <input type="checkbox"/> refrigerator        | <input type="checkbox"/> frying pan          |
| <input type="checkbox"/> can opener       | <input type="checkbox"/> tank filter         | <input type="checkbox"/> electric oven       |
| <input type="checkbox"/> clock            | <input type="checkbox"/> aquarium            | <input type="checkbox"/> electric shaver     |
| <input type="checkbox"/> coffee maker     | <input type="checkbox"/> hedge cutter        | <input type="checkbox"/> rug shampooer       |
| <input type="checkbox"/> slide projector  | <input type="checkbox"/> electric typewriter | <input type="checkbox"/> shoe polisher       |
| <input type="checkbox"/> iron             | <input type="checkbox"/> home movie          | <input type="checkbox"/> VCR                 |
| <input type="checkbox"/> electric saw     | <input type="checkbox"/> vacuum cleaner      | <input type="checkbox"/> movie projector     |
| <input type="checkbox"/> drill sander     | <input type="checkbox"/> radio               | <input type="checkbox"/> tape recorder       |
| <input type="checkbox"/> television       | <input type="checkbox"/> garage door         | <input type="checkbox"/> electric toothbrush |
| <input type="checkbox"/> washing machine  | <input type="checkbox"/> warming tray        | <input type="checkbox"/> electric mixer      |
| <input type="checkbox"/> bun warmer       | <input type="checkbox"/> water softener      | <input type="checkbox"/> hair dryer          |
| <input type="checkbox"/> floor polisher   | <input type="checkbox"/> snow blower         | <input type="checkbox"/> record player       |

# Energy Eaters in my Home

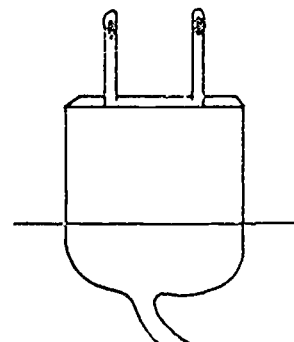
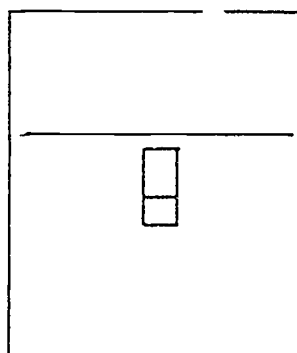
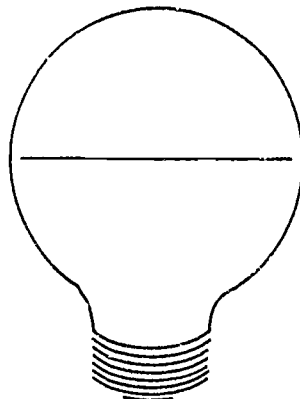
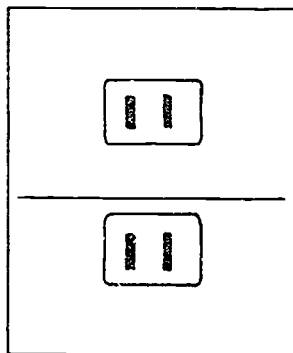
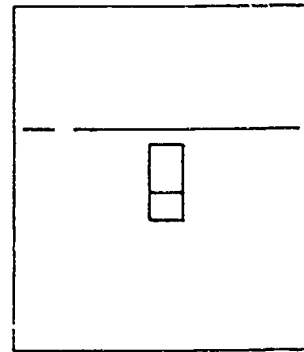
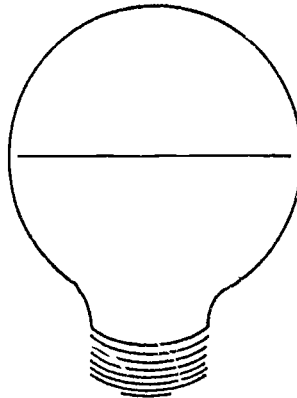
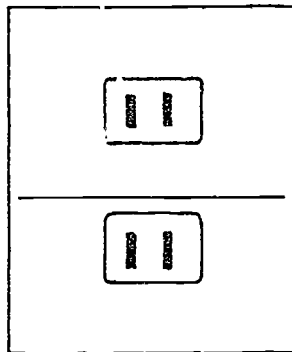
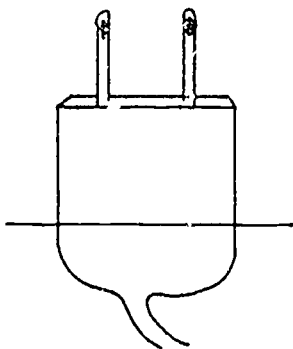
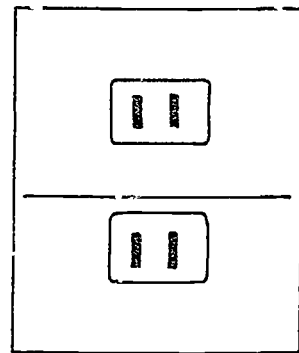
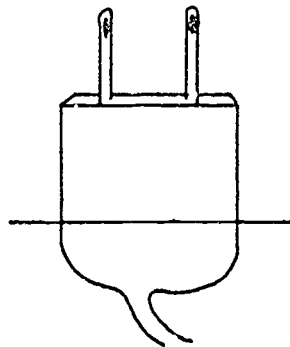
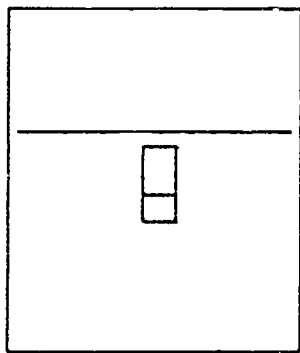
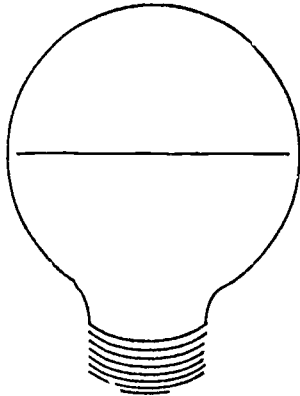
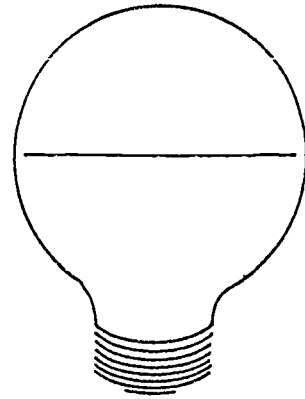
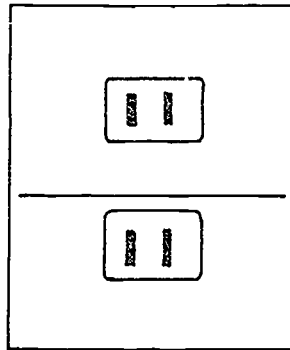
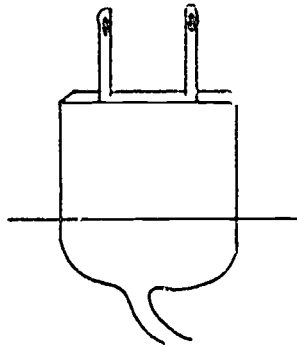
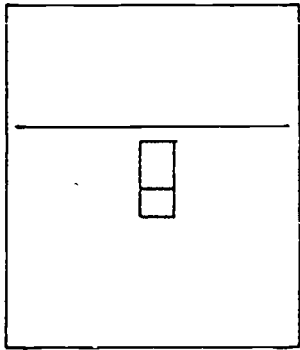

Number them in order of their importance to you. Put an "N" under each item which is necessary for living. Put an "L" under each item which you could live without (luxury).

*LUXURY*

or

*NECESSITY*

How many say "Yes,  
it is a luxury"

*NAME OF ITEM*

How many say "Yes,  
it is a necessity"

# CAN YOU GUESS?

Name \_\_\_\_\_

HOW MANY POUNDS OF COAL ARE USED ANNUALLY TO PROVIDE ELECTRICITY TO OPERATE THESE APPLIANCES?  
(Draw a line from the appliance to the lump of coal with the number of pounds you guess to be correct!  
(Answers below)

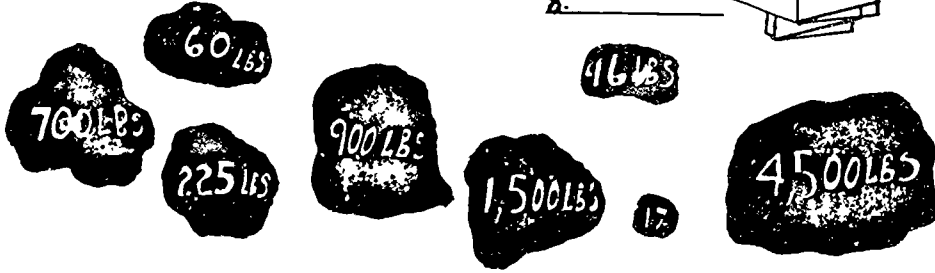
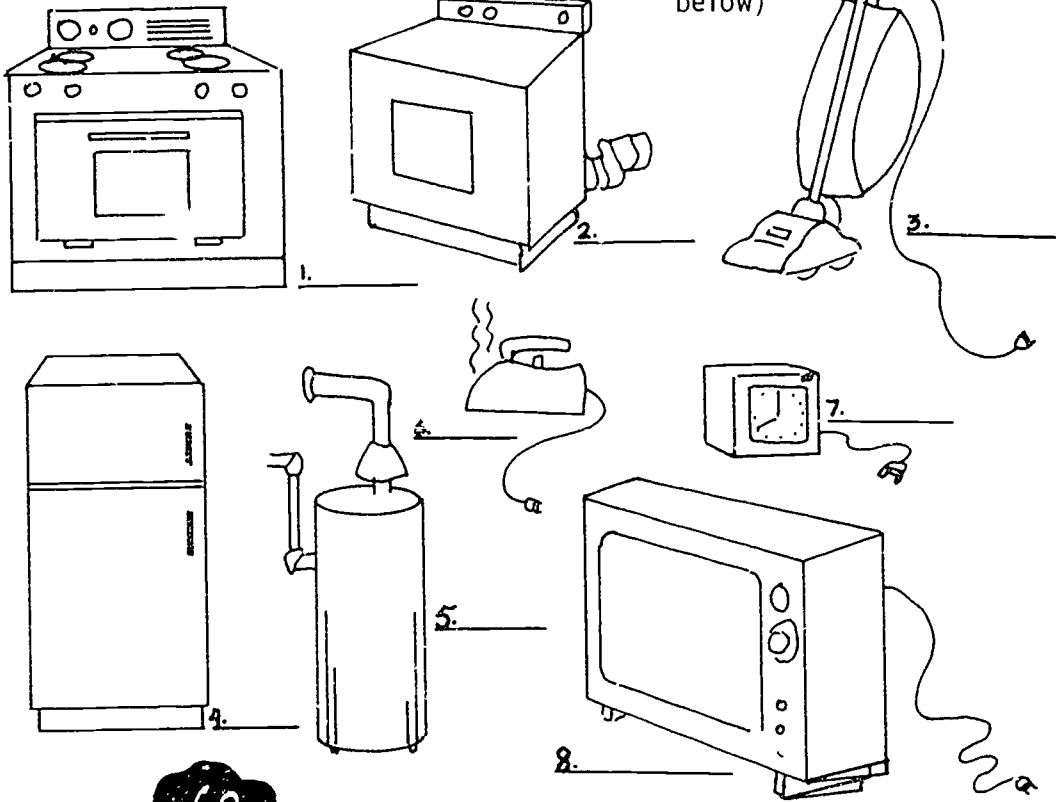

## Answers

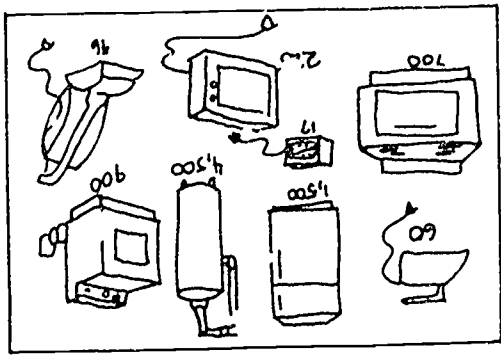

**TITLE** Consumption! My How You've Grown!

---

**SUBJECT** Language Arts, Social Studies      **LEVEL** Intermediate

---

**ACTIVITY IN BRIEF**

Students conduct interviews to learn how various activities were energized in the past. They compare past and present use of energy.

---

**OBJECTIVE**

Students will state reasons why we, as Americans, are consuming ever-increasing quantities of energy.

---

**MATERIALS**

handouts - I-14a, b, c, d, e, f  
chart of unfinished statements

**TIME**

Awareness - 30 minutes  
Concept development - 2 days  
Application - 45 minutes

---

**LEARNING CYCLE**

**AWARENESS** - The students study a pictorial graph (see I-14a). They contemplate why our consumption of fossil fuels have grown over the years. Guesses are made as to how various activities were done before electricity. (See I-14b.)

**CONCEPT DEVELOPMENT** - The students conduct an interview with two previous generations (Parents? Grandparents?) dealing with energy needs past and present. (See I-14c and I-14d).

**APPLICATION** - The students share and compare their interview results. Each student may finish one of the following statements: (Make a chart for everyone to see)

I learned that. . .  
I was surprised that. . .  
I didn't know that. . .  
I forgot that. . .  
I relearned that. . .  
I discovered that. . .  
I decided I would. . .

Each student also will sign a contract promising an action to reduce consumption of electricity. (See I-14e). Upon successful completion of the contract, an award would be presented (I-14f).

EVALUATION - Each student will state five reasons why Americans consume more energy today than they did 30 years ago.

---

**FOLLOW-UP/BACKGROUND/SUPPORT**

Invite an older citizen from within the community to share their childhood energy use experiences with the students.

**SOURCE OF ACTIVITY**

Adapted from Watt's Happening.

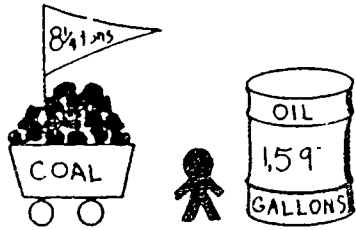

In 1950 each American used this much.

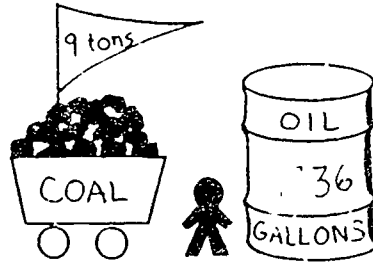

In 1960 each American used this much

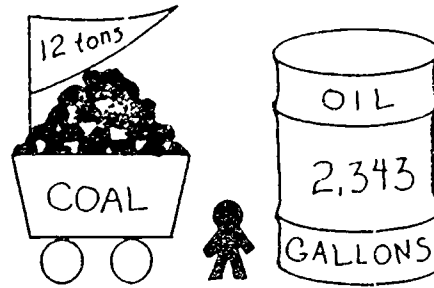

In 1970 each American used this much.

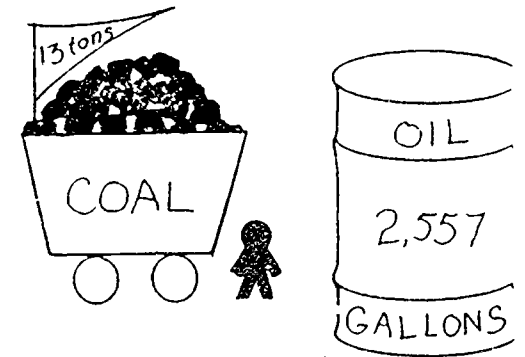

In 1980 each American used this much.

I am surprised that

I learned that

I feel that

I am going to save petroleum by



## What did they do then? (Pre-electricity)

Before curling irons	children played games or read books for entertainment.
Before electric or gas furnaces	children bundled up with warm clothing and sat by the fire.
Before TV was invented	clothes were washed by hand in big tubs.
Before ovens	candles were burned in the evening.
Before washing machines	they chopped up firewood to use for cooking.
Before clothes dryers	children sat under the shade of a tree or swam in a nearby stream to cool off.
Before lights	firewood was burned for warmth.
Before air conditioners	food was kept cool in cellars, or ice houses. Much of the food was dried.
On cold days, before people had furnaces	clothes were hung out to dry in the wind and the sun.
Before hot water heaters	girls curled their hair by wrapping their hair around wet rags.
Before refrigerators	water was heated on the fire to be used for bathing

# When I was your age.....

What did you  
do for:

**Grandparent**  
the year was \_\_\_\_\_

**Parent**  
the year was \_\_\_\_\_

**Me/Now**  
the year is \_\_\_\_\_

**Transport-  
ation**

**Home  
Heat**

**Food (fresh,  
frozen, or  
canned**

**Clothes  
Washing**

**Food: cooking  
and keeping  
it cold**

**Recreation -  
TV?  
Radio?**

**Electrical  
appliances  
in kitchen**

**What do you  
miss about the  
"good old  
days"?**

# When you were my age did you have a.....

Grandparents	Parents	Today 19__	
<input type="checkbox"/>	<input type="checkbox"/>	<input type="checkbox"/>	T.V. set
<input type="checkbox"/>	<input type="checkbox"/>	<input type="checkbox"/>	vacuum cleaner
<input type="checkbox"/>	<input type="checkbox"/>	<input type="checkbox"/>	clothes dryer
<input type="checkbox"/>	<input type="checkbox"/>	<input type="checkbox"/>	electric dishwasher
<input type="checkbox"/>	<input type="checkbox"/>	<input type="checkbox"/>	electric toothbrush
<input type="checkbox"/>	<input type="checkbox"/>	<input type="checkbox"/>	radio
<input type="checkbox"/>	<input type="checkbox"/>	<input type="checkbox"/>	electric razor
<input type="checkbox"/>	<input type="checkbox"/>	<input type="checkbox"/>	electric mixer
<input type="checkbox"/>	<input type="checkbox"/>	<input type="checkbox"/>	phonograph
<input type="checkbox"/>	<input type="checkbox"/>	<input type="checkbox"/>	air conditioner
<input type="checkbox"/>	<input type="checkbox"/>	<input type="checkbox"/>	freezer
<input type="checkbox"/>	<input type="checkbox"/>	<input type="checkbox"/>	refrigerator
<input type="checkbox"/>	<input type="checkbox"/>	<input type="checkbox"/>	central heating
<input type="checkbox"/>	<input type="checkbox"/>	<input type="checkbox"/>	automatic washer
<input type="checkbox"/>	<input type="checkbox"/>	<input type="checkbox"/>	electric or gas stove
<input type="checkbox"/>	<input type="checkbox"/>	<input type="checkbox"/>	blender
<input type="checkbox"/>	<input type="checkbox"/>	<input type="checkbox"/>	power mower
<input type="checkbox"/>	<input type="checkbox"/>	<input type="checkbox"/>	other:
<input type="checkbox"/>	<input type="checkbox"/>	<input type="checkbox"/>	_____
<input type="checkbox"/>	<input type="checkbox"/>	<input type="checkbox"/>	_____
<input type="checkbox"/>	<input type="checkbox"/>	<input type="checkbox"/>	_____
<input type="checkbox"/>	<input type="checkbox"/>	<input type="checkbox"/>	_____

I, \_\_\_\_\_

**do solemnly pledge to**

**conserve** \_\_\_\_\_

**by** \_\_\_\_\_

\_\_\_\_\_  
\_\_\_\_\_

starting on this \_\_\_\_\_ day of \_\_\_\_\_,

19\_\_\_\_.

\_\_\_\_\_  
**Signature**

\_\_\_\_\_  
**Witness**



**AWARD**

Presented to

---

for

**SUPER**

**ENERGY SAVING**

**PRACTICES**

&

Conservation

Awareness

**TITLE** Catch a Sunbeam

---

**SUBJECT** All areas

**LEVEL** Intermediate

---

**ACTIVITY**

Each student chooses a project to make to demonstrate solar energy at work.

---

**OBJECTIVE**

Each student will demonstrate the potential of the sun's energy with a project.

---

**MATERIALS**

handouts - I-15a, I-15b, I-15c,  
I-15d, I-15e  
students collect materials for project  
selected

**TIME**

Awareness - 15 minutes  
Concept development - variable  
as needed  
Application - ongoing all day

---

**LEARNING CYCLE**

**AWARENESS** - The student considers the sun as a source of energy. The class makes a list of all possible ways to harness the energy of the sun. (The sun can heat a pool, tan our body, grow a plant, dry our clothes, warm a house, etc.)

**CONCEPT DEVELOPMENT** - The students study the pictures and describe the workings of each solar powered item. Each student chooses one project to make and demonstrate. (See I-15a, I-15c, I-15d)

**APPLICATION** - The students participate in a Solar Celebration Day. A schedule of events might include:

1. Greet the Sun. (Read A Way to Start the Day, by Byrd Baylor.
2. Write and share sun-sational poems, haiku, and sun shins.
3. Unlock and eat locked in sunshine by doing the orange activity. (see background).
4. Make a solar still.
5. Make and tell time with solar clocks.
6. Make a sundial.
7. Dry fruit, make tea, cook hot dogs, and bake brownies using solar energy gathering apparatus.
8. Make sun prints using chemically-treated paper or colored construction paper.
9. With paint brushes and buckets of water, create evaporating art work on the playground.
10. Design some solar experiments. (See I-16e)
11. Make shadow chalk pictures (trace around a shadow with chalk on the blacktop). Do a shadow show.

12. Sunbathe, soak up the sun. Lay in the round shape of the sun with rays radiating out.
13. Make leaf prints to exemplify the solar energy locked within.
14. Sing familiar or make your own sun songs.
15. Paint a sunset.

The Sun Celebration Day planning is limited only by the boundaries of the imagination of teacher and students.

EVALUATION - Ask each student to explain how his/her project demonstrates the potential of the energy of the sun.

---

#### FOLLOW-UP/BACKGROUND INFORMATION

##### The Orange Activity

The children form a circle seated upon the floor or ground around a pile of oranges. Their legs are extended and spread to allow the teacher to roll oranges (sun rays) to each student. Each orange package has locked within it the energy of the sun or canned sunshine. The teacher directs the activity with the following dialogue:

The sun is locked up within the orange package you are holding. Look carefully at this little package of energy. Observe the markings, its texture, any little bumps, nicks, grooves. How could you tell this orange from any other oranges? Smell it. Close your eyes and feel it. Touch it to your cheek. You will know it from all others because it is special to you.

Now poke your fingernail gently into the outer skin. Remove a tiny fragment of the orange and smell it, then taste it. Experience the sensation.

Starting at the point to which it was fastened to the tree, proceed to peel. If carefully done, the outer skin will fall away in one piece, depicting the sun's rays. Here is where the energy of the sun has been locked in little sections. Take one section out. Smell it, and observe it with the light passing through, then taste it. Feel the sun's energy as it becomes a part of your body. The sun, locked inside, is now going to give you energy. The sun's energy will be converted into energy for your body.

Concentrate on the taste of the orange. Take one section and trade it with someone near you. Taste it. Compare it to your own. How does it differ? How are they alike? No two oranges are the same. Each tree uses the same sun but other factors enter in to cause the differences in the taste of each orange. There are differences in soil, differences in temperature, differences in amount of shade and so forth. But what each orange does share is the fact that without the sun, there would be no oranges. And the sun locks its energy within each orange and your orange passes on that energy to your body.

Continue to eat your orange now and don't forget that the energy you'll be using today is coming from the sun!

The sun is the primary source of all energy on earth. It is locked up within our fossil fuels. It supplies the energy for evaporation, starting the rain cycle. It is the parent of the streams and rivers and, which, if collected in dams, creates hydroelectricity. It heats the earth unequally giving rise to wind energy. The sun is the cleanest, most inexhaustible energy source. It is the energy challenge of the future. However, in Iowa, only about 1% of the energy used comes from direct solar energy.

To understand more of the mechanics of solar energy, contact a resource person to talk on solar energy or a visit to a solar home would be beneficial.

SOURCE OF ACTIVITY     Janey Swartz  
                                 The Orange Activity by Duane Tomson



# Catch a Sunbeam

Name \_\_\_\_\_

Label each solar energy user and explain how each one works.

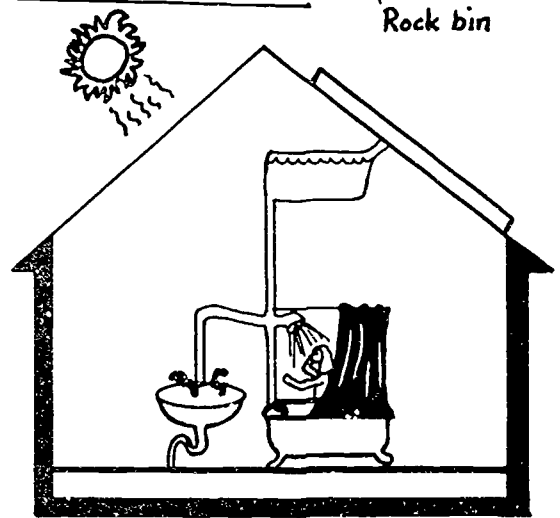
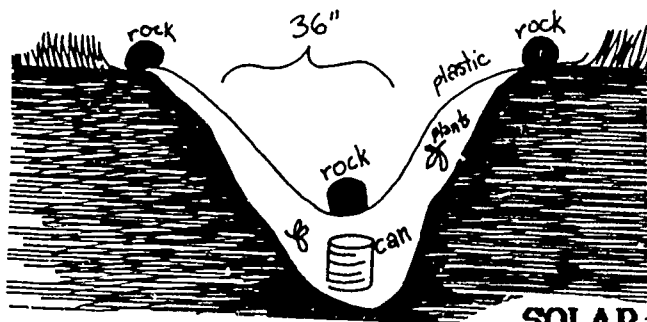
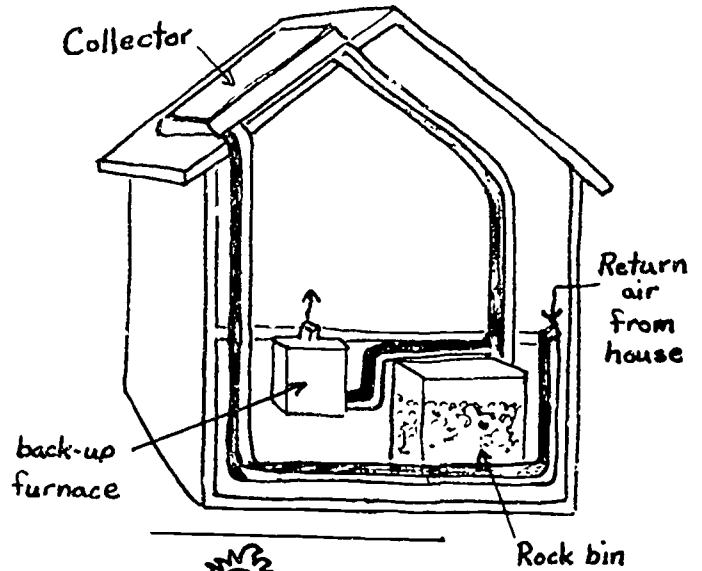
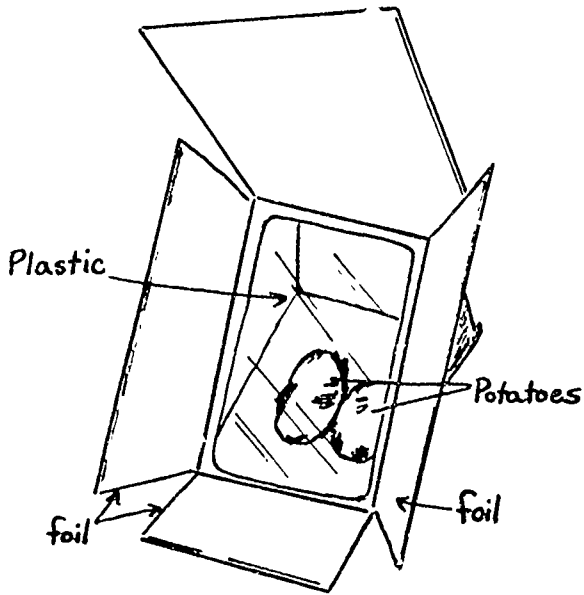

**SOLAR:**

- greenhouse
- cooker
- still (water collector)
- oven
- mittens
- water heater
- home

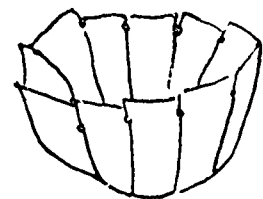
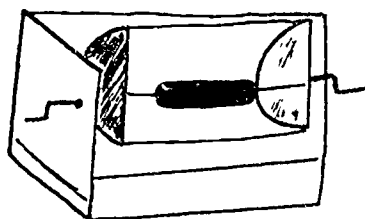
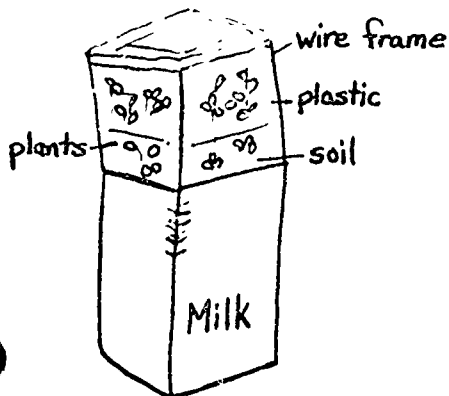

1. Cut out the sun clock.
2. Cut on lines A and B.
3. Fold on the dotted line so that the sun is at a 90° angle to the bottom half of the sun clock.
4. Draw a string from A to B with a knot at each end to keep it tight in place.
5. Note how the sun will cast a different shadow of the string on the clock, depending on the time of day.
6. Keep it in your pocket so you can tell the time!

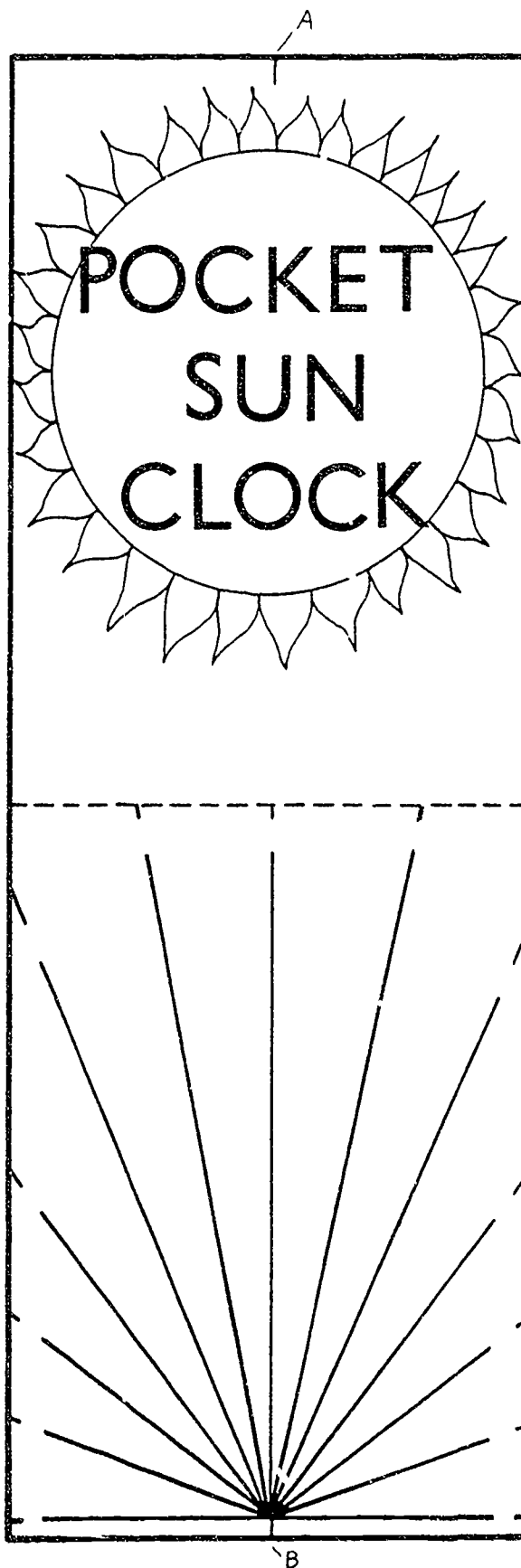

# Sun Mittens

1. Cut out 10 of these triangles from any old lightweight cardboard you can find.
2. Wrap each triangle with aluminum foil so it's covered on one side. Keep the foil smooth.

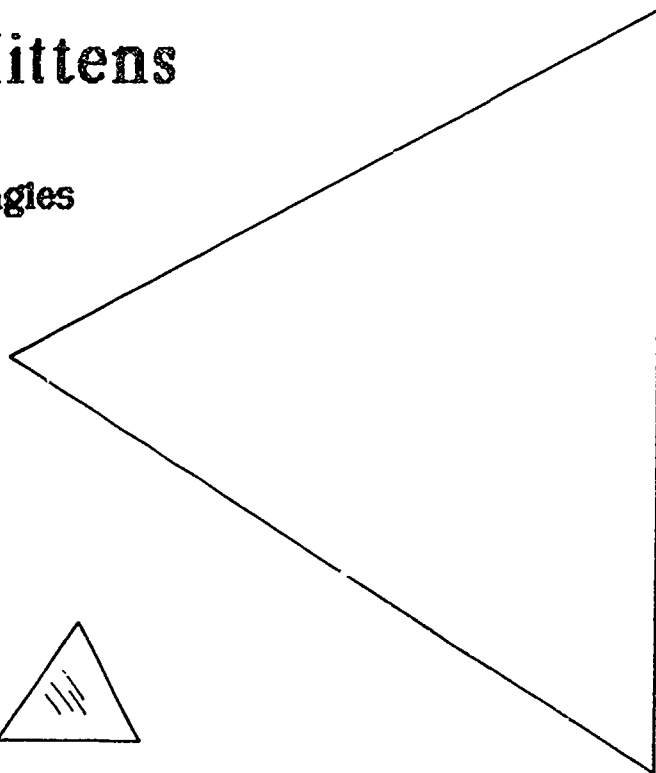
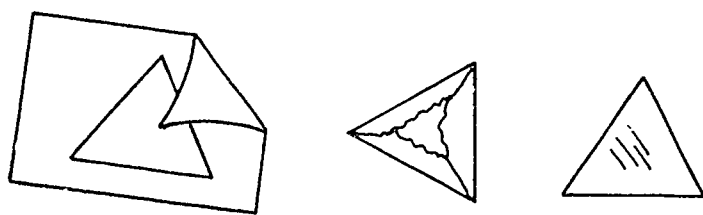

3. Punch a hole in one point of each triangle.
4. Attach all the triangles together with a paper fastener.
5. Spread out the triangles into a flat circle. To make it bowl-shaped, press the circle into a small bowl.
6. When it is bowl-shaped, staple the outside edges.
7. Place the hand warmer outside in the sun. When your hands need to be warmed up, hold them in the bowl for a while and they'll warm up.

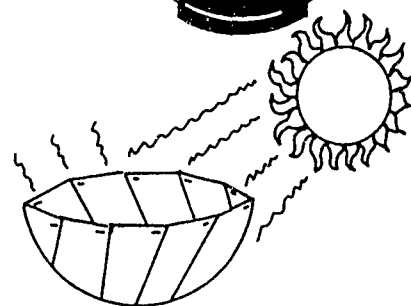
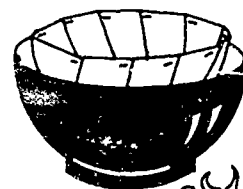
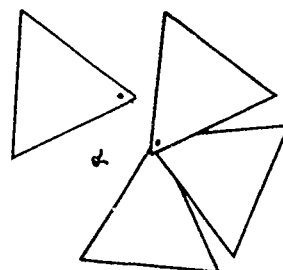

**Hurrah for sun power!!**

## Solar Fruit Dryer

### You need:

- cardboard box (15" or taller)
- black paint
- fiberglass, plastic, or aluminum screening (Do NOT use galvanized)
- 3 coat hangers (or strong wire)
- clear vinyl (window covering plastic is good)
- duct tape

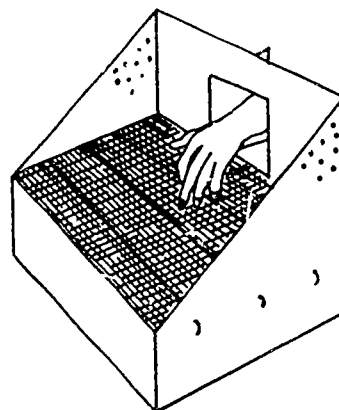

1. Cut off sides and front of box as shown.
2. Paint the inside of the box or cover it with black paper.
3. Cut a door in the back. Make the "hinge" part stronger with duct tape.
4. Poke holes on the side with a pencil.
5. Run 3 wires 6" from the bottom of the box. (This will form the rack to hold the screen.)
6. Cut screening to fit the length and width of the box.
7. Place the screen on the rack.
8. Tape the clear covering (vinyl) snugly over the top of the box.

### How to use your solar fruit dryer.

- Put fruit on the screen rack. Tape the door shut so heat can't escape.
- Put the dryer on concrete or asphalt, outside, aimed directly at the sun. Keep adjusting it as the sun moves.
- Keep the vinyl clean and tightly attached.
- Clear sunny warm days are best for drying.

Name \_\_\_\_\_

**Question: What is the best color to catch the sun's rays? (black or white?)**



I will \_\_\_\_\_  
 \_\_\_\_\_  
 \_\_\_\_\_  
 \_\_\_\_\_

I need these things: \_\_\_\_\_  
 \_\_\_\_\_  
 \_\_\_\_\_

Conclusion: I discovered that: \_\_\_\_\_  
 \_\_\_\_\_  
 \_\_\_\_\_

**Question: What material (sand, water, salt, paper) stores the sun's heat the longest?**

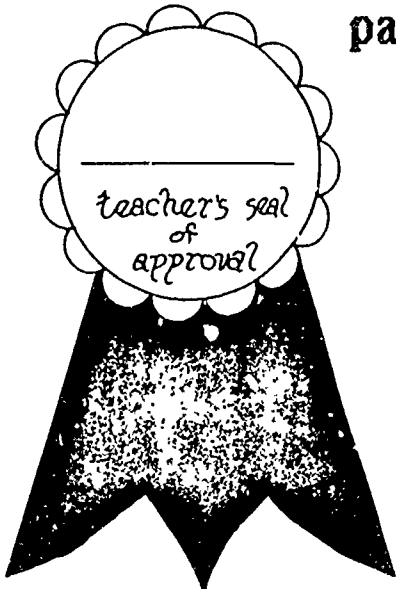

I will \_\_\_\_\_  
 \_\_\_\_\_  
 \_\_\_\_\_  
 \_\_\_\_\_

I need these things: \_\_\_\_\_  
 \_\_\_\_\_  
 \_\_\_\_\_

Conclusion: I discovered that: \_\_\_\_\_  
 \_\_\_\_\_  
 \_\_\_\_\_

**TITLE** BUY RIGHTS

**SUBJECT** Social Studies

**LEVEL** Intermediate

**ACTIVITY IN BRIEF**

Students buy rights with tokens throughout the day. Tokens illustrate energy distribution worldwide. Students become a world council working to solve a crisis energy situation.

**OBJECTIVE**

Each student will make a statement regarding world-wide energy distribution.

**MATERIALS**

peanut M & Ms  
clear cups  
tokens as needed (16a)

**TIME**

Throughout the day

**LEARNING CYCLE**

**AWARENESS** - The teacher distributes the students into the various continents and gives each continent a clear plastic cup of peanut M & Ms using the information on the following chart. The M & Ms represent the total amount of energy used by each continent.

<u>Country</u>	<u>Representing what % of world's population</u>	<u>Consuming what % of world's available energy</u>	<u>M &amp; Ms</u>
North America	8%	39%	32
South America	6%	8%	6
Europe	14%	24%	20
Asia	61%	18%	14
Africa	10.5%	8%	6
Australia/Oceania	.5%	3%	2

Example: To determine the number of students in North American in a class of 20, take  $.08 \times 20$  or 1.6 (rounded off to 2) students.

**CONCEPT DEVELOPMENT** - The students, still in their designated groupings, receive energy tokens in proportion to how much energy that continent consumes in a year. (If 300 tokens are available, 117 would go to the North American energy czar, etc.). Each of the two North Americans would have 57 or 58 tokens to spend. In contrast, each Asian would represent countries with far fewer tokens to spend. Each continent will select an energy czar who will allocate however he/she decides to distribute energy tokens (see I-16a).

Toward the end of the day, the students will have many feelings to express (mostly having to do with the unfairness of token distribution). The teacher guides the students' understanding of the unequal distribution of energy on a worldwide scale. The students finish "I learned..." statements. (See I-16b)

**APPLICATION** - The class becomes a world council made up of the various continents. Each "continent" elects a leader. An emergency meeting is called because nonrenewable energy sources have reached crisis levels and the leaders must meet to decide how the remaining energy sources should be distributed. The members of the continent act as an advisory board. Each leader and board meet to discuss their distribution and their appeal for a share of the remaining resources. Each leader presents the plan to the world council.

**EVALUATION** - Each student will write and read a statement to be presented to the world council of how energy should be distributed.

---

#### **FOLLOW-UP/BACKGROUND INFORMATION**

Environmental problems such as resource depletion, exist because much of the human world is dependent on sources of energy which are in danger of running out. A worldwide ethic and commitment would promote harmony and balance and secure the future of our planet earth. The students need to be aware of the fact that they are a part of the total world scene and that their actions, great or small, effect the world energy picture. When an individual makes a commitment to live a lifestyle in harmony and balance with nature, that individual has recognized the importance of each persons' impact upon this planet.

#### **SOURCE OF ACTIVITY**

Janey Swartz

A sample chart of arbitrary prices. (The teacher develops a chart for the class)

1 cracker	1 token
10 minutes of "free time" reading	5 tokens
a cup of Kool-aid	5 tokens
5 minutes of extra recess	5 tokens
use of the golden marker	1 token
sticker grab bag	10 tokens
a plant or stuffed animal to sit on your continent for 1 hour	10 tokens
time to listen to music on the head phones	3 tokens
time to tell a joke to the class	1 token
a walk down the hall for break	6 tokens
the right to chew gum in class	8 tokens
the right to paint a picture at the easel	5 tokens
a fun page to do	1 token

Be creative, and have the students add to the list.



Name \_\_\_\_\_

I learned that \_\_\_\_\_

I didn't know that \_\_\_\_\_

I feel bad that \_\_\_\_\_

I feel strongly about \_\_\_\_\_

I think that \_\_\_\_\_

I hope that \_\_\_\_\_

I wish that \_\_\_\_\_

I wonder \_\_\_\_\_

**TITLE** Twinkie Twinkie That's Your Name  
How I Wonder Whence You Came

**SUBJECT** Social Studies

**LEVEL** Intermediate

**ACTIVITY IN BRIEF**

The students trace the flow of energy from the source of the raw materials to the final production of a Hostess Twinkie.

**OBJECTIVE**

Each child will be able to trace an energy flow from source to the community.

**MATERIALS**

twinkie  
large sheet of paper, markers,  
crayons, etc.  
large world wall map  
string, pins

**TIME**

awareness - 30-40 minutes  
concept development - 45-60  
minutes

**LEARNING CYCLE**

**AWARENESS** - Twinkie is placed in a prominent position. The teacher states that there is a lot of energy packaged in this item. The class makes a list of all the raw materials used in producing the twinkie; categorizing each as renewable or non-renewable.

RENEWABLE

sugar  
tree (cardboard)  
flour (wheat)  
eggs

NONRENEWABLE

petroleum (ink)  
petroleum (wrapper)

etc.

**CONCEPT DEVELOPMENT** - Students form groups of three or four. They draw a twinkie in the center of a large sheet of butcher paper. A mural or poster is created showing the energy involved in getting these products to the store shelf. (The gasoline for the tractor in the wheat field. . . the tanker fuel carrying sugar cane, etc.) Upon completion, each group shares with the larger group.

**APPLICATION** - A large world map is displayed and strings are stretched (using pins or tape) from the community to the various locations where the raw materials are obtained. Little tags label the products.

**EVALUATION** - Each student will be able to trace a product from its present form to its origin.

**FOLLOW-UP/BACKGROUND INFORMATION**

More strings could be attached to the map throughout the energy unit so that the students can better visualize a world-wide perspective and energy flow.

The world recycle might be included in this activity. Some paper products can be recycled. It takes less energy to recycle cans and paper than it takes to produce these products from the raw materials. Cans and newspapers are products easily recycled. There are many items which could be recycled if we use our creativity and resourcefulness. Give each child a grocery sack and see how many uses can be made of the sack. Make recycled paper and display recycled paper products. Encourage creativity with items we normally throw away.

A follow-up activity toward the end of the school day would be to spread some newspapers on the floor, dump the wastebasket and have the students examine the discarded items. What potential reusable items exist and what rightfully should have been discarded? These could be classified as a Wastebasket Survey.

**SOURCE OF ACTIVITY**

Adapted from Minnesota Energy Activities, "Big Mac," by John and Deb Miller.

**TITLE** The Energy Patrol

---

**SUBJECT** All areas

**LEVEL** Intermediate

---

**ACTIVITY**

Students form an energy patrol and supervise a major component of energy conservation in their school. They check for lights in empty rooms, record classroom temperatures and make observations about energy being consumed.

---

**OBJECTIVE**

Each student will be able to describe actions which might be taken to reduce energy consumption and costs in any building.

---

**MATERIALS**

energy patrol certificate  
energy patrol bands  
handouts - I-18b, c

**TIME**

ongoing throughout the month  
(10 min/day for monitoring)

---

**LEARNING CYCLE**

**AWARENESS** - The principal presents the energy patrol certificate to the class. (See I-18a) The authority is given to the class to monitor and supervise energy conservation measures and to effect changes where necessary to guarantee reduced energy consumption and costs. The challenge is to see a noticeable decrease in energy consumption made evident through monthly meter readings. The students learn how to read a meter. They record and date the school meter reading.

**CONCEPT DEVELOPMENT** - The students develop a check list of areas to monitor (see I-18b, c). Students are assigned on-duty patrol days. **ENERGY PATROL** bands should be worn. Each morning 2 patrol members will check to see how much electricity has been used since the previous morning. Two other patrolers check empty classrooms for lights during recess, lunch periods, and after school. Rooms with lights off will get a happy-face "Save-a-Watt" sticker. Those wasting energy are reminded with a sad-face "Save-a-Watt" sticker. Before the patrol commences its daily duties, a school-wide announcement will be made to inform the other classes about the patrol.

**APPLICATION** - Data is collected for a designated span of time (a month is recommended). The data is evaluated to see if any savings were made. Recommendations are made as to how the school can further cut the energy cost. An assembly will be held to report any findings and to present awards to the most energy efficient rooms. Recommendations will be made and the entire school will be challenged to reduce energy consumption through its united effort.

EVALUATION - Students will be able to report to the principal and, if called upon, the School Board, to describe building energy use and potential energy loss areas within the building.

---

#### FOLLOW-UP/BACKGROUND INFORMATION

Here are some recommendations to consider:

The thermostat could be adjusted (reduced) in different parts of the building depending on use. (For example, lower temperatures could be kept in the gym due to higher activity levels there.)

Students could be encouraged to keep extra layers of clothing at school, enabling them to adjust their needs to temperature fluctuations, also allowing the thermometer to be lowered a few degrees.

Curtains could be opened or closed to control temperature. Open curtains for extra heat, shut them for cooling purposes.

Registers could be closed in rooms not being used.

Students should report windows and doors that require caulking or weatherstripping.

Children can be encouraged to quickly enter and exit through doorways to prevent heat loss or gain. A monitor could be posted at doorways during morning arrival, recess, and afternoon departure.

Fresh air ventilation instead of air conditioning could be used when possible.

An energy audit could be made for the school and recommendations by the officials could be presented to the class. This information could also be relayed to the other classes by the Special Patrol reporters.

This could be an ongoing project throughout the school year. The challenge would be to see continued energy savings monthly. Of course, there will be season fluctuations which need to be understood and appreciated by the students. The students are challenged to be constantly thinking of ways to save energy all year long.

#### SOURCE OF ACTIVITY

Adapted from The Energy Patrol project at North Scott Community School District, and Tom Fredricksen.

This certificate hereby proclaims  
the formation and development

of the

# Energy Patrol

with the students in \_\_\_\_\_ class  
Teacher's Name

The purpose of this distinguished honor is  
to encourage the pursuit and continuance  
of energy conservation measures by the  
students of \_\_\_\_\_  
Name of School

\_\_\_\_\_  
Date

\_\_\_\_\_  
Principal's signature

\_\_\_\_\_  
Teacher's signature

# Temperature Patrol

Record the temperature for each day  
Take it at different times of the day.

Date →

Week \_\_\_\_\_

Hallway					
Gym					
Restroom					
Office					

Check:

- Temperature is OK without being too warm.
- Curtains are opened when the sun's heat is needed and closed when the sun's heat is not needed.
- Warm clothing is worn on cold days and light clothing is worn on warm or hot days.

# Light Patrol

Date each check. Be sure to check at different times of the day, such as lunchtime, recess, and before and after school.

☺ means good conservation of electricity.

☹ means waste of electricity.

Date →

Week # \_\_\_\_\_

Hallway

Gym

Restroom

Office

Check:

- Lights are turned off next to windows where sunlight can be used.
- Lights are turned off in hallways, classrooms, closets, etc. when not in use.



**TITLE** Energize Me!

**SUBJECT** Science

**LEVEL** Intermediate

**ACTIVITY IN BRIEF**

The students evaluate their home environment by filling out an energized home report card.

**OBJECTIVE**

Each student will be able to evaluate an "energized home" to identify energy savings.

**MATERIALS**

report card for each student - I-19a  
 contract for each student - I-19b  
 awards as needed - I-19-c, d, and e

**TIME**

awareness - 15-30 minutes  
 concept development - 30-45  
 minutes  
 application - 15 minutes

**LEARNING CYCLE**

**AWARENESS** - Each student receives a copy of "The Energized Home Report Card" (see I-19a). The teacher and students read and discuss how each statement positively affects energy conservation.

**CONCEPT DEVELOPMENT** - The student takes the report card home and "grades" each item. The help of the family may need to be solicited.

**APPLICATION** - The student decides what energy saving steps will be implemented at home. A contract is drawn up (see I-19b). Six weeks later, the student's home is re-evaluated. An award is presented to anyone whose energy home report card has improved. (See I-19c and I-19d)

**EVALUATION** - Each student will state three things he/she can do at home to save energy.

**FOLLOW-UP/BACKGROUND INFORMATION**

The student could solicit several volunteers to take part in an energy-audit. Each volunteer would grade his/her home and a follow-up evaluation would determine if energy saving practices had been put into use. The student would receive an award if the volunteer's report card had improved.

One should realize that of the total energy used in homes, 70% is used to heat and cool the home, so energy saving actions should start here: insulating and weatherstripping in the home is important for energy savings (air leakage contributes to 30 to 40% of the heating bill). 20% of the total energy consumed is used to heat water, and 10% is for lights, cooking, and small appliances.

SOURCE OF ACTIVITY     Janey Swartz  
                              Awards by Rose Wilson

# The Energized Home Report Card of \_\_\_\_\_

- A = Always = 10
- B = Usually = 8
- C = Sometimes = 5
- D = Hardly ever = 2
- F = Never = 0

Grade Chart

- A = 251-300
- B = 151-250
- C = 61-150
- D = 51- 60
- F = 50 or below

**Electricity**      Date      Date

• Light bulbs and shades are clean.		
• Our hot water heater is set at _____ 110° = A 110°-125° = B 125°-140° = C 140°-...?... = D		
• The hot water heater is insulated.		
• The refrigerator coils at the rear or bottom are clean and free of lint		
• The refrigerator is not crowded so there is free air flow.		
• The refrigerator is set at 38-40°.		
• Frost in the freezer is less than 1/4" deep.		
• Stove reflectors are clean.		
• Door seal on oven door is tight.		
• Door seal on refrigerator is tight.		
• Door seal on freezer is tight.		

\* The test for door seals is this. Close the door on a dollar bill. If you can remove it the door is too loose, and a new rubber gasket is needed.

**Water**      Date      Date

• A brick is in the toilet water tank.		
• There are no dripping faucets.		

**Heating and Cooling**

• Thermostat is set for 68° or less in winter.		
• Air conditioner is set for 78° or higher in summer.		
• Furnace filters are changed once a month.		
• Doors and registers are shut to rooms not in use.		
• Storm windows and doors are installed, weather-stripped, and caulked.		
• Foam gaskets are installed behind outlet and switch plates to keep cold air from coming in.		
• Attic floors are insulated.		
• Floors over unheated rooms are insulated.		
• Exterior walls are insulated.		
• Attic walls are insulated.		
• Heat ducts are not blocked.		
• There are evergreen trees on the north.		
• There are deciduous trees, vines, or shrubs on the south and west to help shade windows in the summer.		
• The first 10 feet of copper pipe coming from your water heater is insulated.		
• Insulated curtains are installed.		
• Plastic covers on windows in the winter (or storm windows are used).		

I-19b

# CONTRACT

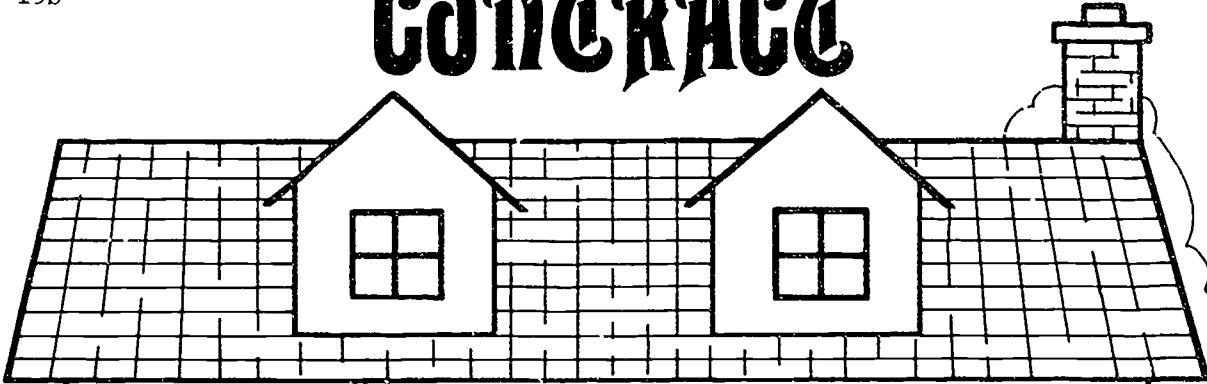

I,

pledge

to energize my home by:

1.

Date:

19

Signature: \_\_\_\_\_

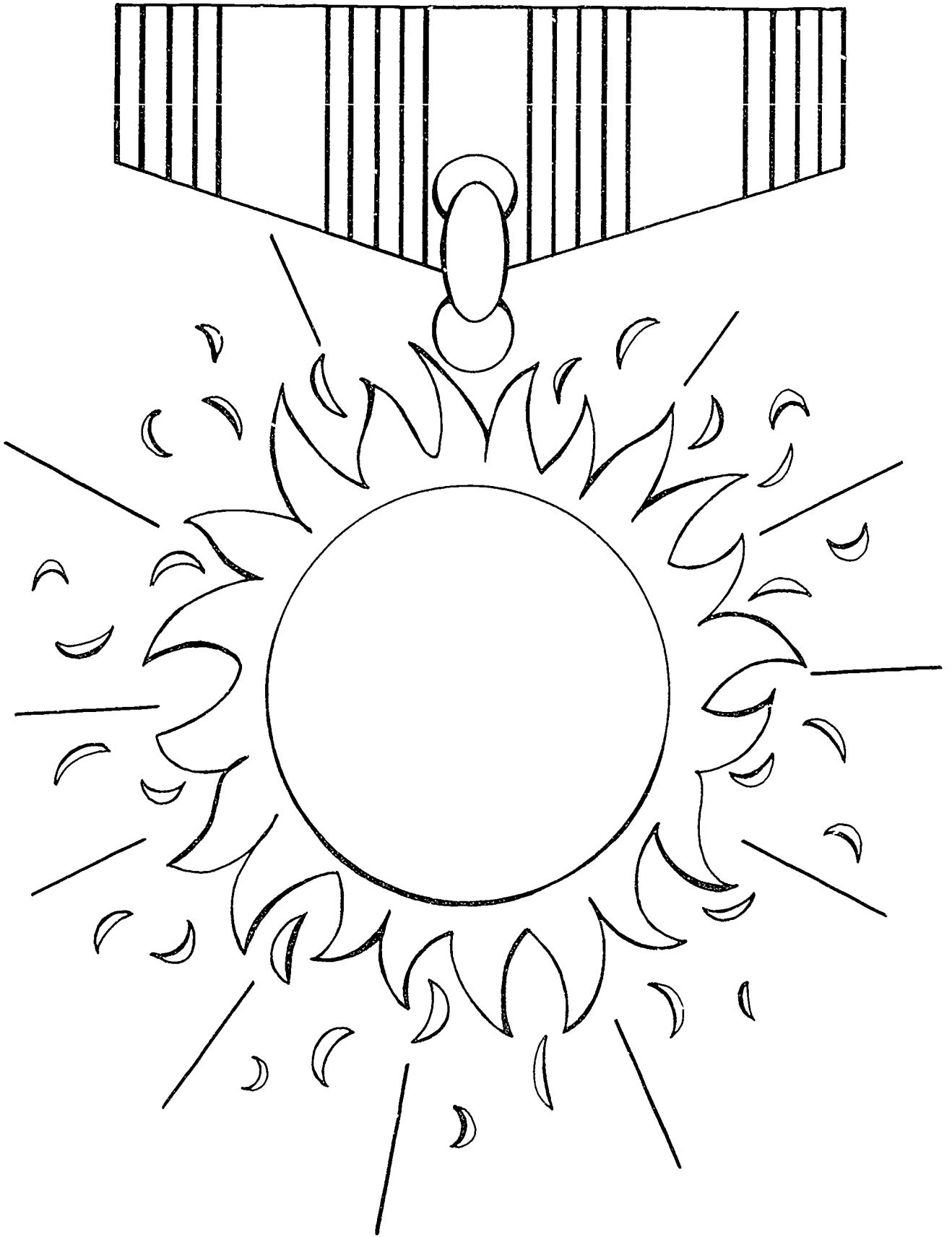

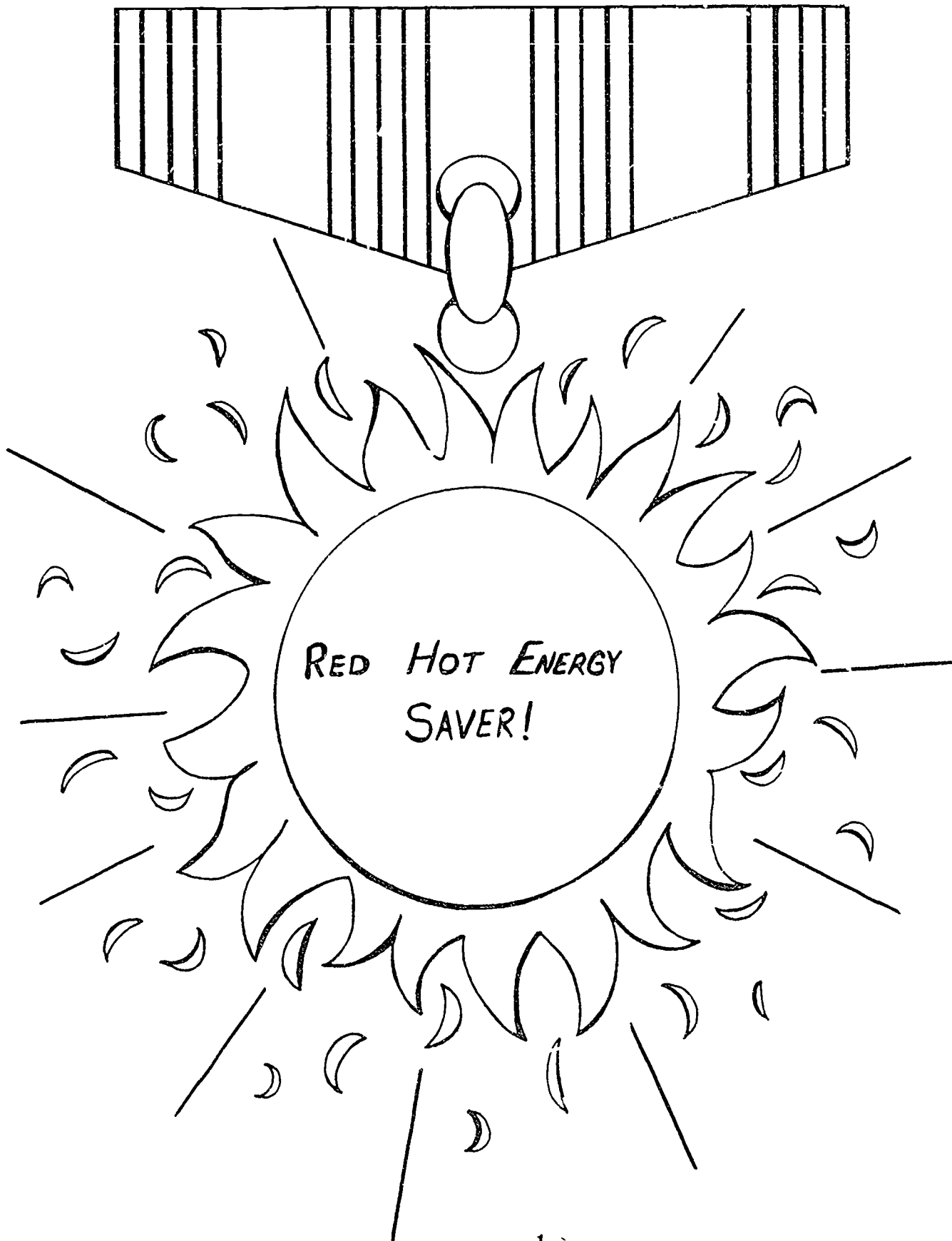

# SUPER ENERGY SAVING AWARD!

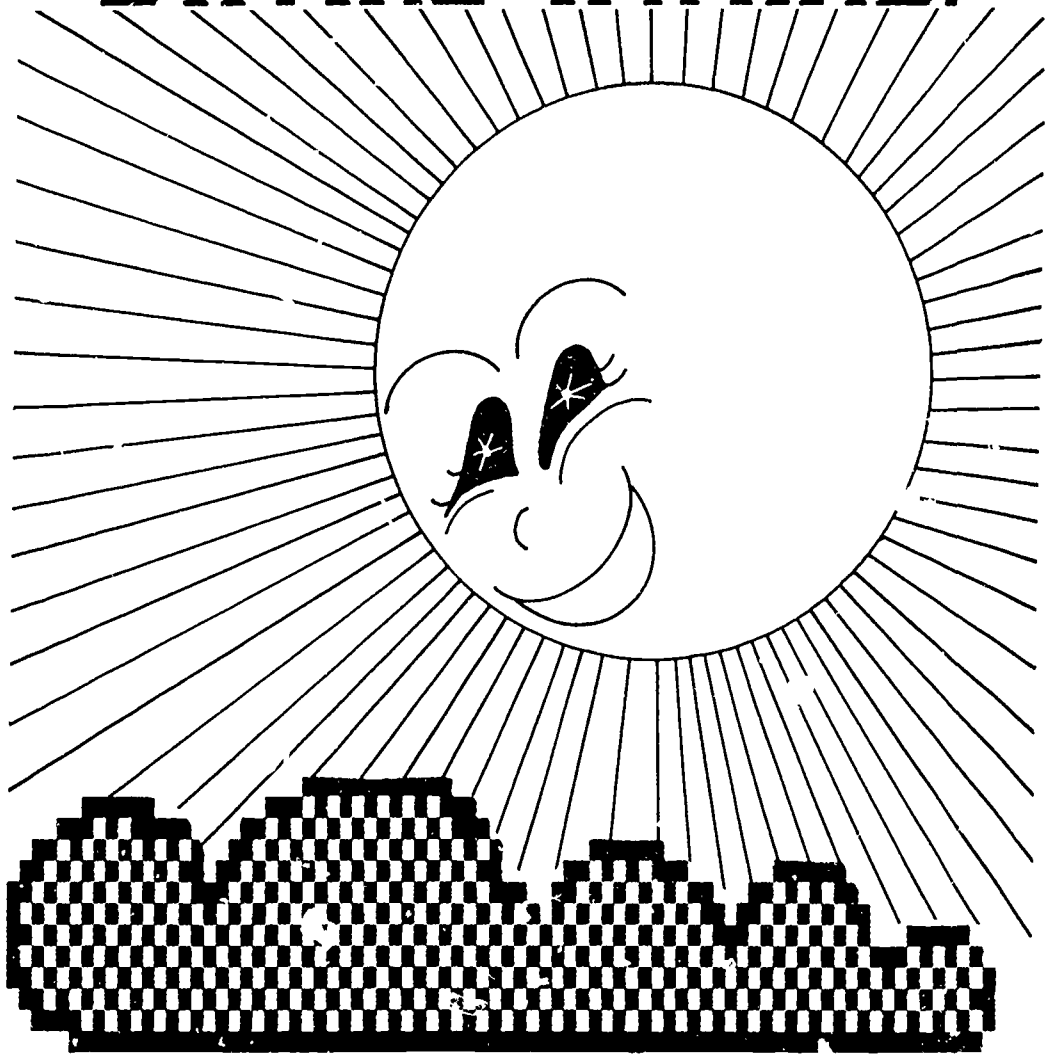

**PRESENTED TO:**

---

**TITLE** Saving Energy Makes Good Cents

---

**SUBJECT** Mathematics

**LEVEL** Intermediate

---

**ACTIVITY**

Students work math problems relating to energy and cost of consumption.

---

**OBJECTIVE**

Each student will be able to measure how certain energy reductions would be cost-saving.

---

**MATERIALS**

handouts - I-20a

**TIME**

awareness - 30 minutes  
 concept development - 45 minutes  
 application - 30 minutes

---

**LEARNING CYCLE**

**AWARENESS** - Students are given a list of appliances with facts pertaining to energy costs. They must estimate how many hours a month and a year their family uses each appliance. (See I-23a) Since family's help may be needed, this project could be homework.

**CONCEPT DEVELOPMENT** - The students do calculations to arrive at cost per month and cost per year to run each appliance. Before arriving at the final energy expenditure for the year, make predictions of energy costs per month. Students will then find their actual average energy costs per month.

**APPLICATION** - Students will rate the items they use according to cost. They will determine which items cost the most to operate in a year. Students will evaluate their consumption of energy and determine where eliminations or reductions could be made in order to cut energy costs. Students develop and write a plan to reduce their family's energy cost.

**EVALUATION** - Student will state how much cost reduction resulted from his/her plan.

---

**FOLLOW-UP/BACKGROUND INFORMATION**

The students may wish to chart their electric/gas bills monthly to see the impact of their behavior changes. A special award could be presented to anyone whose costs were reduced because of these changes.



The greatest savings of energy occurs with conservation of those things which consume the greatest amount of energy. Since heating and cooling our homes accounts for 70% of the total energy consumed, it would be wise to concentrate energy saving efforts here. 20% of the total energy consumed is used to heat water. This, too, is an area where energy-saving practices would more evidently effect changes. The remaining 10% is consumed to run small appliances. The refrigerator uses the most; followed by the electric dryer; then the oven. Other major users are the T.V., and lights by virtue of their constant use.

Additional Background Information is provided on the following two pages from Energy and Mans Environment.

#### SOURCE OF ACTIVITY

Janey Swartz

Appliance	Average Watts	Hours of Operation Per Year	KWH Use
Heater			
Portable	1000	1080	1080
Radiant	1270	135	170
Heating Pad	65	120	8
Hot Plate	1250	72	90
Iron	1100	145	160
Ironer	1500	145	222
Lawnmower	1000	130	100
Lighting (varies with size of home and living habits)			1000
Night Light	10	2900	29
Post Light (Photo Cell)	100	4200	420
Projector			
Slide	500	50	25
Motion Picture	700	50	35
Radio			
Console	75	1400	125
Table	50	1400	70
Radio-phonograph	110	1000	110
Range	12000	100	1200
Self Cleaning Oven	4000	50	200
Razor	15	60	1
Record Player			
Console	160	300	50
Table	75	300	25
Recorder	100	100	10
Refrigerator - 12 cu. ft.			
Standard	240	3125	750
Frost Free	320	3800	1220
Refrigerator-Freezer - 14 cu. ft.			
Standard	225	3540	1450
Frost Free	360	5150	1850
Roaster	1320	360	475
Rotisserie	1400	360	500
Sewing Machine	100	120	12
Sun Lamp	300	50	15
Television			
Black & White	240	1500	360
Color	350	1500	525
Toaster	1150	48	55
Toothbrush	5	10	<u>1/</u>
Vacuum Cleaner			
Portable	210	60	13
Standard	600	120	70
Vibrator	40	50	2
Waffle Iron	1100	24	26
Washer <u>2/</u>			
Automatic	500	200	100
Nonautomatic	285	200	75
Water Heater (varies considerably with clothes washing and bathing habits)			4800-9600

1/ Less than 1 kwh

2/ Does not include electricity to heat water

# AVERAGE WATTAGE OF VARIOUS HOME ELECTRICAL APPLIANCES

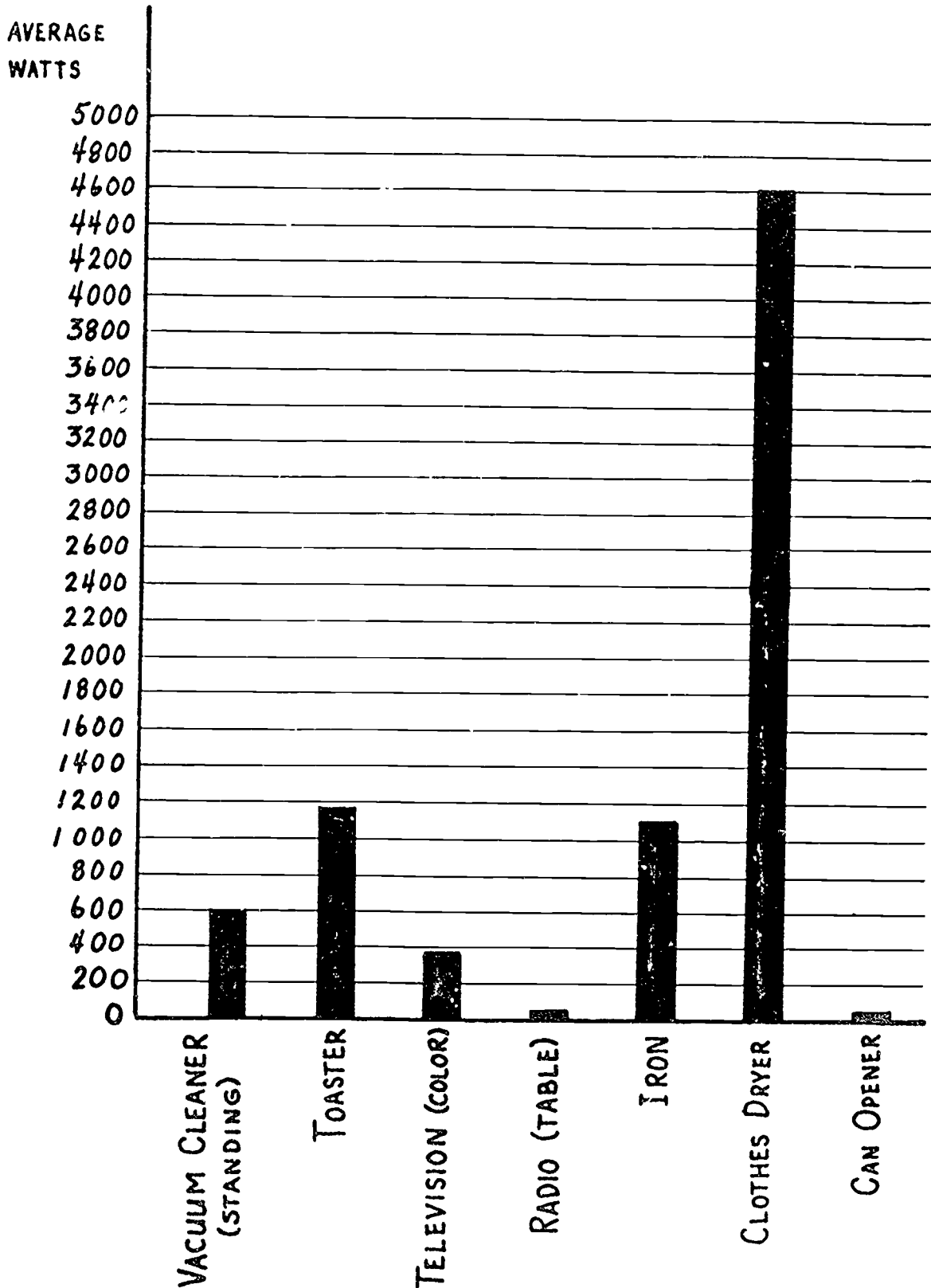

\_\_\_\_\_, Come on down!!!  
 You are the next contestant on "Is the Price Right?"

APPLIANCE	COST PER HOUR	HOURS A MONTH IN USE	COST /MONTH	COST /YEAR
Water heater				
gas	\$.01	_____	_____	_____
electric	.05	_____	_____	_____
Clothes dryer				
gas	\$.09	_____	_____	_____
electric	.31	_____	_____	_____
Oven				
gas	\$.03	_____	_____	_____
electric	.08	_____	_____	_____
Furnace				
gas	\$.05	_____	_____	_____
TV	\$.02	_____	_____	_____
Radio	.01	_____	_____	_____
Stereo	.015	_____	_____	_____
Light Bulb	.005	_____	_____	_____
Electric blanket	.01	_____	_____	_____
Hair dryer	.12	_____	_____	_____
Toaster	.12	_____	_____	_____
Air conditioner	.23	_____	_____	_____
Wash machine	.02	_____	_____	_____
Refrigerator	.015	_____	_____	_____
Freezer	.015	_____	_____	_____
Dishwasher	.08	_____	_____	_____

What do you predict your electricity bill for the month? \_\_\_\_\_  
 gas bill for the month? \_\_\_\_\_

Find out: actual electric bill \_\_\_\_\_

actual gas bill \_\_\_\_\_

**TITLE** Making the Grade!

---

**SUBJECT** All areas

**LEVEL** Intermediate

---

**ACTIVITY IN BRIEF**

The student evaluates his/her energy lifestyle using a report card format.

---

**OBJECTIVE**

The student will be able to describe some every day energy conservation practices and state or describe a conservation ethic.

---

**MATERIALS**

**TIME**

report card for each student - I-21a  
contracts  
I-21b (optional)

awareness - 30-45 minutes  
concept development - 30 minutes  
application - variable

---

**LEARNING CYCLE**

**AWARENESS** - Each student receives an energy report card (see 21a). The teacher and students read and discuss how each action positively affects energy conservation.

**CONCEPT DEVELOPMENT** - The student completes each report card item and determines a grade for each item on the report card.

**APPLICATION** - The student re-evaluates his/her lifestyle and makes a commitment to take certain energy conserving actions. A contract is drawn up and signed by the student regarding those changes in behavior (see I-15d). Six weeks later the student re-evaluates his/her behavior. Any improvement would necessitate an award. (See I-15e, I-19c or I-19d)

**EVALUATION** - The student will report "progress" made throughout the year.

---

**FOLLOW-UP/BACKGROUND INFORMATION**

This could become an ongoing activity, with regular grading schedules, four or more times a year. New items may be added. Perhaps the students could use their own report card format. I-21b may be used as a follow-up.

**SOURCE OF ACTIVITY**

Janey Swartz

# Energy Report Card of \_\_\_\_\_

- A = Always = 10
- B = Usually = 8
- C = Sometimes = 5
- D = Hardly ever = 2
- F = Never = 0

## Electricity

	Date	Date
• I turn off lights I'm not using (and when I leave the room)		
• I use natural light (sunlight) whenever possible		
• I turn off the TV, radio or stereo when I'm not using them		
• I don't stand looking in the refrigerator with the door open I close it as quickly as possible		
• I wash only full load in the dishwasher and in the washing machine		
• I use the clothesline on warm windy days instead of using the dryer		

## Water

• I keep water in the refrigerator to cool it instead of running the faucet to cool it		
• I don't leave the water running while I'm brushing my teeth or sudsing up my hands		
• I shower instead of bathing and save up to 10 gallons of water each time.		
• If I wash dishes by hand, I don't leave the water running to rinse each plate separately		

## Heating and Cooling

	Date	Date
• I wear extra warm clothing in winter and keep the thermostat down		
• I turn the thermostat down at night and use extra blankets		
• I open curtains when the sun is shining and close them when it isn't shining (in the winter)		
• I close the curtains when the sun is shining in (on warm summer days)		
• I do not use an air conditioner unless it is very, very hot		
• I do not use an air conditioner at all		
• I keep doors and windows shut while air conditioner or furnace is running		
• I do not stand in the doorway with the door open to talk to someone		

## Transportation

	Date	Date
• I ride my bike whenever possible instead of using the car (or I walk)		
• I carpool whenever I can!		
• I try to make only necessary trips in my car (I save-up errands to do in one trip)		
• I always check to see that the tires are properly inflated		
• I turn off my car when I am waiting (at drive-up windows for a train, while someone runs into the store, etc)		

\*See I- 21b

## Should You Shower or Bathe?

### Take a bath

Fill your tub with water as usual.  
Before you step into the tub,  
measure the depth of the water.

Bath water \_\_\_\_\_ inches.

### Take a shower

Do this when you need one. Before  
you begin, close the bathtub drain  
so the shower will collect in the tub.  
When you have finished with your  
shower, measure the depth of the  
water that has collected.

Shower water \_\_\_\_\_ inches.

What is the difference in the amount of water you used?

\_\_\_\_\_ inches

\* A surprising fact is that if people took \_\_\_\_\_  
instead of \_\_\_\_\_ a lot of energy would be saved.

**TITLE** Is That a Fact?

---

**SUBJECT** Reading, Art

**LEVEL** Intermediate

---

**ACTIVITY IN BRIEF**

The class reads a fact related to energy consumption. The student designs a banner, button, bumper sticker, or flyer stressing an energy saving behavior dealing with that fact. Each student tries to convince someone to make a change of behavior to save energy.

---

**OBJECTIVE**

Each student will propose reasons for his/her conservation idea and justify them.

---

**MATERIALS**

art materials as needed by the students  
contracts - I-22a  
handouts

**TIME**

a daily 15-20 minute project

---

**LEARNING CYCLE**

**AWARENESS** - A "fact for the day" is written on the board for the children to discuss. (See background for a "starter list")

**CONCEPT DEVELOPMENT** - The student considers an energy-saving action having to do with the fact for the day. Each student designs a bumper sticker, banner, button, or flyer to distribute to someone, such as a neighbor, relative, friend, etc.

**APPLICATION** - If the student can find a "convert" (someone who will agree to sign a mini-contract (see I-22a) promising to put the energy saving practice into action) he/she can earn a star on the super star converter chart. (See background) Use the conservation quiz to stimulate ideas and discussion. (See I-22b)

**EVALUATION** - Each student will contract for a prescribed number of "I promise" statements (see I-22a).

---

**FOLLOW-UP/BACKGROUND INFORMATION**

A class chart can list energy saving practices. Each student who convinces someone to participate will earn a star.



Here is a starter list for the teacher to use. Every day one statement should appear on the chalkboard. The students will consider the statement and brainstorm possible energy saving actions dealing directly with the fact of the day:

- \* Changing the home thermostat by one degree will change heating requirements by about 3 percent. (Reducing the setting from 70° to 68° will save 6%.) By turning the thermostat down 10° from 10:00 p.m. you can save 15-20% from your heating bill.
- \* A light bulb consumes less energy during its starting stage than during a single second of normal operation. (Always turn lights off when they are unnecessary, even for a few seconds.)
- \* 4/5 ounce of oil is burned each minute the electric dryer is used. 1/10 cubic feet of gas is used each minute the gas dryer is used.
- \*
  1. Do not run the dryer longer than necessary.
  2. Clean the lint filter each time the dryer is used.
  3. Don't dry half loads. Fill the machine before using.
  4. Use the clothes line whenever possible.
- \* If we raise the average to 2 people riding in each car, the nation could save 5 billion gallons of gasoline a year. Carpool when possible.
- \* Each peek in the oven drops the temperature 25° to 50°. Don't open the oven door unless necessary.
- \* If you are away, energy will be saved if you lower your heat to about 50°.
- \* A lot of energy will be saved if rooms not being used are closed off to heat or air conditioning.
- \* Using the sun in the winter can save energy. By closing the curtains at night, you can keep the heat in your house.
- \* In the summer you can use curtains to keep the sun out. In the winter, you can use the sun to heat by opening the curtains, and then by closing them at night, you can help keep the heat in your house. Wise use of curtains can save as much as \$15.00 out of each \$100.00 spent for heat.
- \* Hot water heating, stoves, and refrigerators use up \$1.00 out of every \$5.00 spent for energy.
- \* Insulation of the hot water tank can save you \$10.00 or more each year on energy cost.
- \* The U.S. citizen throws away an average of 1 ton of trash yearly.
- \* Of the total energy used in homes, 70% is used to heat and cool the home, 20% is used to heat water and 20% is for lights, cooking, and small appliances.

- \* Electric blankets use only small amounts of electricity. You can turn the house heat down at night, to 60° or below, and still stay warm. Use a sheet, the electric blanket, and heavy covers on top to keep the heat next to your body. Wear a stocking hat!
- \* Insulation in the attic could save \$15.00 out of each \$100.00 usually spent for heat.
- \* Dressing for warmth and turning down the heat saves energy. Wool and polypropylene are much warmer than man-made fabrics like nylon and rayon.  
Wearing several layers of clothing keeps you warmer than 1 heavy layer would.
- \* Wear long underwear (wool or polypropylene is best) and save energy by turning down the heat.
- \* Cracks, holes, and leaks rob you of heat. Leaks can cost you up to 20% of your heat bill. Sealing up windows, doors, chimneys, foundation can save lots of energy!  
Small cracks and openings around doors and windows let as much heat escape as a large open window would!
- \* A lot of heat is lost through the floor. Covering the floor with rugs (or several layers of newspapers with rugs over these) will save energy.
- \* You save energy if you turn the heat down when you leave the house even for a few hours.
- \* The average family of 4 uses about 65 gallons of water each day.
  - Bath = 30 gallons
  - Shower = 20 gallons
  - Load of dishes = 10 gallons
  - Automatic washer = 32 1/2 gallons
  - Washing hands = 2 1/2 gallons (if you keep it running the whole time)
  - Brushing teeth = 1 gallon (if you keep it running while brushing)
- \* Changing furnace filters once a month saves energy.
- \* Keeping cars in tune could reduce our gas consumption by 10%.
- \* Reducing the temperature of the water heater to 110° would save 15-20% a year on our electric bill.
- \* Petroleum is conserved if plastic utensils, styrofoam cups, plastic bags, plastic sandwich bags, styrofoam plates were not used.
- \* Two ways we make our refrigerators use more energy are by opening the door more than necessary and by putting warm things inside them.
- \* Making water hot takes a lot of energy. It takes about 1 ounce of fuel oil, or 1 cubic foot of natural gas, or 1/4 kilowatt of electricity to heat 1 gallon of water!

- \* About 2000 kw/hrs. of electrical energy are used to light the average home for a year. 150 gallons of oil or more than 3/4 ton of coal must be burned in a power plant to produce this amount of electricity for your home.
- \* Covering the pot saves energy. It doesn't take as much energy to get something to boil if the lid is on.
- \* The stove uses more energy to boil something rather than to simmer it. Most things cook just as well if simmered rather than boiled.
- \* Keeping car tires properly inflated saves gas. Underinflated tires can decrease fuel economy as much as 1 mile per gallon. Radial tires may give you from 0.5 to 1 more mile per gallon.

#### SOURCE OF ACTIVITY

Janey Swartz

I promise to \_\_\_\_\_  
in order to save energy.

\_\_\_\_\_  
(signature)

-----  
I promise to \_\_\_\_\_  
in order to save energy.

\_\_\_\_\_  
(signature)

-----  
I promise to \_\_\_\_\_  
in order to save energy.

\_\_\_\_\_  
(signature)

-----  
I promise to \_\_\_\_\_  
in order to save energy.

\_\_\_\_\_  
(signature)

-----  
I promise to \_\_\_\_\_  
in order to save energy.

\_\_\_\_\_  
(signature)

-----  
I promise to \_\_\_\_\_  
in order to save energy.

\_\_\_\_\_  
(signature)

# CONSERVATION QUIZ

Dripping hot water faucet	Room with thermostat set at 68° or lower	Lights on in an unoccupied room	Electric can opener	Car making a quick stop	Washing machine with cold water only
Grow a garden	Electric blanket	Doors and windows closed in cold weather	Car easing to a smooth stop	TV off when no one watching	Car pool
Public building too hot or too cold	Fluorescent lights	Outside lights burning during the day	Lamps with more than 70 watt bulbs	Car with only one passenger	Take showers instead of baths
Car coming to a quick stop	Wear sweaters and warm clothing in cold weather	Bicycle instead of using car	Electric toothbrush in use	People walking to work or school	Car speeding over 55 mph
Sun allowed to shine into home to give warmth	Color TV	Door or window open with heat or air conditioning on	Full loads in the washing machine	Room with thermostat above 68°	Conserve paper
Car idling with no driver	Lights off when no one using them	Electric knife in use	House with no storm windows	Clothes hanging out to dry	Recycling of paper, glass, metal

## Directions

1. Mark each block with an x when you actually find what is described.
2. Color the blocks red which show a waste of energy.
3. Color the blocks yellow which show saving of energy.